

VIA 3 PERIMETER MRI

RECESSED PATTERN

STATIC WHITE



Project: _____

Type: _____

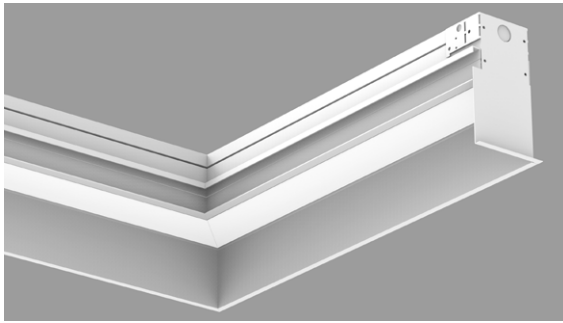

Via 3 Perimeter Deep Pattern

DESCRIPTION

Via Perimeter MRI fixtures are designed specifically for MRI suites in healthcare applications and constructed with non-ferrous materials. With remote drivers, they create a continuously illuminated "slot" at the wall/ceiling intersection. Lighted corners with adjustable end sleeves are available. Via Perimeter installs in grid or drywall ceilings in a choice of three arrangements: level, shallow 1", and deep 3 1/4". An additional antimicrobial finish option is available.



SENSORS
For latest information on sensors, click [here](#).



IC RATED

Up to 121 lm/W performance

Order Guide

► A drawing of your pattern is required - anything from a line drawing to an architectural drawing.

LUMINAIRE ID	OPTIC	LIGHT SOURCE ²	CRI	LUMEN PACKAGE	COLOR TEMP.	PATTERN LENGTH
		SW				
V3PERMRILPAT - Via 3 Perimeter MRI Level Pattern V3PERMRISPAT - Via 3 Perimeter MRI Shallow Pattern V3PERMRIDPAT - Via 3 Perimeter MRI Deep Pattern	HLO - High-Efficiency Lambertian Optic ARFO ¹ - Asymmetric Room Fill Optic ¹ Not available with Deep fixtures.	SW - Static white ² Chromawerx SOLA, DUO and QUADRO also available. Consult factory.	80CRI - 80 CRI 90CRI - 90 CRI	500LMF - Low output 500 lm/ft 750LMF - Medium output 750 lm/ft 1000LMF - High output 1000 lm/ft	27K - 2700K 30K - 3000K 35K - 3500K 40K - 4000K 50K - 5000K	##FT##IN(##X##FT##IN-##X##FT##IN-...) ³ - ##FT##IN : total nominal length of pattern in feet and/or inches ##X : quantity of each section ##FT##IN : nominal length of each section in feet and/or inches Continuous runs: lengths over 12' ³ Minimum fixture length is 4'.

CORNER TYPE ⁴	VOLTAGE	REMOTE DRIVER ^{8,9}	ELECTRICAL	ELECTRICAL SECTIONS (optional) ^{14,15}
#LEVI2C(##) - 2-way leveled inside corner #LEVO2C(##) - 2-way leveled outside corner ⁴ Specify quantity (#) and angle (##) for each required corner type. ⁵ Not available with ARFO ⁶ Minimum angle is 45°.	120V - 120V 277V - 277V UNV - 120V-277V 347V ⁷ - 347V ⁷ Only available with RD1 driver.	RD1 - 1% 0-10V RDA ¹⁰ - DALI RLDE1 ¹⁰ - Lutron Hi-Lume 1% Eco RELD1 - eldoLED 1% ECODrive 0-10V RELD0 - eldoLED 0.1% SOLOdrive 0-10V ⁸ PoE (Power-over-Ethernet) compatible. Consult factory for details. ⁹ A remote driver box is provided. ¹⁰ On-site commissioning is required.	1C - 1 circuit #MC ¹¹ - Multi circuit EC - Emergency-powered fixture NL - Night light fixture DL - Daylight fixture GTD ^{12,13} - Generator transfer device fixture ¹¹ Specify total number of circuits (#), including any required for electrical section options. Provide drawing or layout specifications. Minimum 4' section per circuit. ¹² Minimum 4' fixture. ¹³ Not available with 347V.	#EC## ¹⁶ - Emergency-powered section #NL## ¹⁶ - Night light section #DL## ¹⁶ - Daylight section #GTD## ^{16,17,18} - Generator transfer device section #EMB ^{18,19} - Emergency battery NA - None ¹⁴ Specify with multi circuit (#MC) electrical option only. ¹⁵ Provide drawing or layout specifications. Consult factory for other configurations. Default section length is 4'. ¹⁶ Specify quantity (#), and section length in inches (##). ¹⁷ Minimum 4' section. ¹⁸ Not available with 347V. ¹⁹ Specify quantity (#). All batteries will be on the same circuit. Each battery powers a 4' section.

MOUNTING	FINISH	OPTIONS ²⁰	ADJUSTABLE SLEEVE (optional) ²²
TG9 - Tegular 9/16" TG15 - Tegular 15/16" TB9 - T-bar 9/16" TB15 - T-bar 15/16" ST - Screw slot T-bar DTR - Drywall trim DTL - Drywall trimless DMF - Drywall mud flange	W - Matte white WA - White antimicrobial Silverwerx CF# - Custom finish, specify RAL#	NEF ²¹ - No end flanges FU120 - Fuse 120V FU277 - Fuse 277V FWC - Flexible whip cable (6' std) CP - Chicago Plenum NA - None ²⁰ Separate codes with a "+" if more than one is specified. ²¹ For wall-to-wall installations.	#TES ²³ - Adjustable end sleeve, specify quantity (#) #TMS ²⁴ - Adjustable mid sleeve, specify quantity (#) NA - None ²² See page 4 for details. ²³ Minimum 5' fixture with EMB option. ²⁴ Minimum 6' fixture. Maximum 1 sleeve per section.

TECHZONE™ & USG Compatible with 4" ceiling

3737 Cote Vertu St-Laurent, Quebec, Canada H4R 2C9
 T (514) 225-4304 F (514) 931-4862
www.lumenwerx.com



Lumenwerx reserves the right to modify product specifications without notification.
 © Lumenwerx, ULC. All rights reserved.
 VIA3-PERIMETER-MRI-PATTERN-SPEC-REV05 February 23, 2026



VIA 3 PERIMETER MRI

RECESSED PATTERN

STATIC WHITE



Dimensions

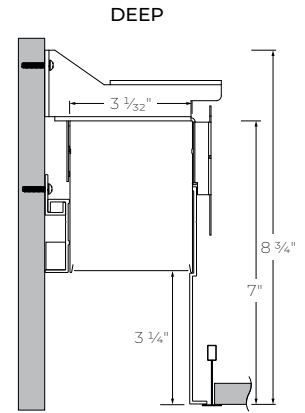
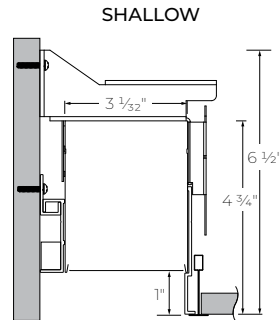
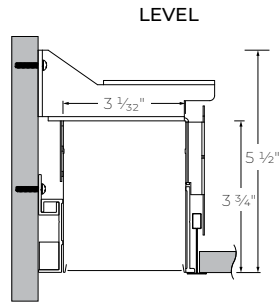

DRYWALL

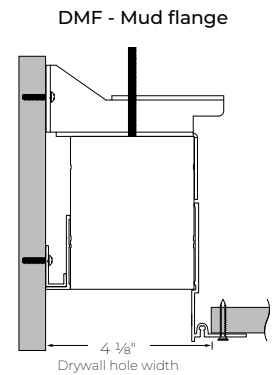
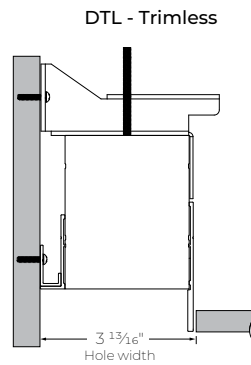
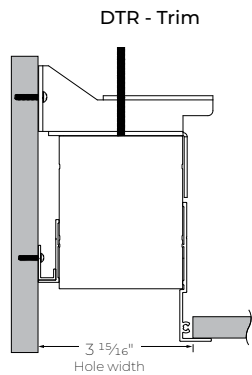

GRID

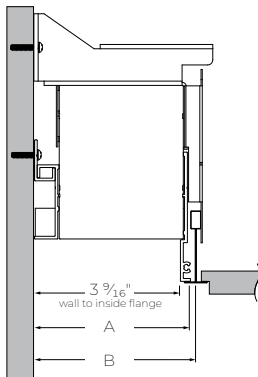

	TC9	TB9	TC15	TB15	ST
	Tegular 9/16"	T-bar 9/16"	Tegular 15/16"	T-bar 15/16"	Screw slot T-bar
A wall to flange	3 13/16"		3 15/16"		3 13/16"
B wall to T-bar	3 7/8"		4"		3 7/8"

VIA 3 PERIMETER MRI

RECESSED PATTERN

STATIC WHITE



Photometrics

Values calculated based on a 4' fixture at 3500K and 80 CRI for all optics.

HLO

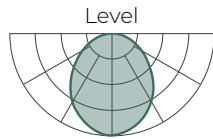

LM/FT	W/FT	LM/W
500	4.1	121
750	6.4	117
1000	8.8	114

ARFO

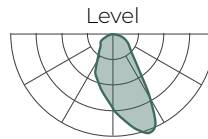

LM/FT	W/FT	LM/W
500	5.5	91
750	8.8	85
1000	12.4	81

Shallow

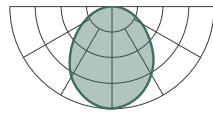

LM/FT	W/FT	LM/W
500	4.2	118
750	6.5	115
1000	9	111

Shallow

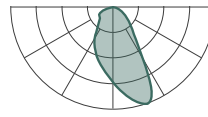

LM/FT	W/FT	LM/W
500	5.6	89
750	8.9	84
1000	12.5	80

Deep

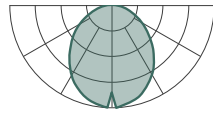

LM/FT	W/FT	LM/W
500	4.4	113
750	6.9	109
1000	9.5	105

MULTIPLIER TABLE

Use this table to get results for different color temperatures and CRI for all photometric tables.

Multiplier - CCT/CRI

CCT	WATTS		LPW	
	80 CRI	90 CRI	80 CRI	90 CRI
2700K	1.05	1.27	0.95	0.79
3000K	1.02	1.23	0.98	0.81
3500K	1.00	1.19	1.00	0.84
4000K	1.00	1.19	1.04	0.84
5000K	0.96	1.12	1.00	0.89

Pattern Layout

CORNER TYPES

LEVELED INSIDE CORNER

LEVELED OUTSIDE CORNER

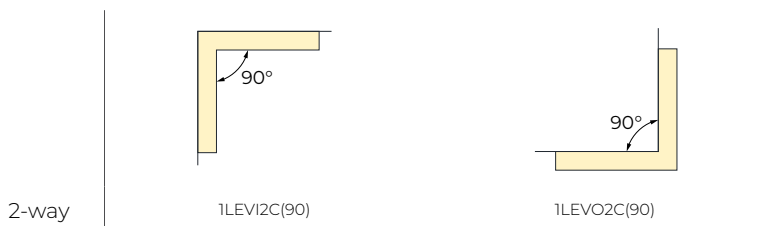

EXAMPLES

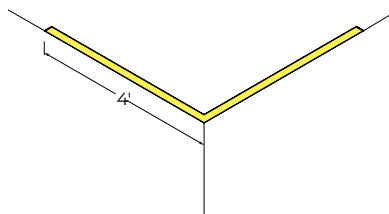

8FT(2X4FT)-1LEVI2C(90)

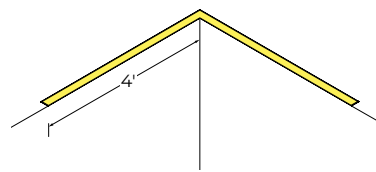

8FT(2X4FT)-1LEVO2C(90)

VIA 3 PERIMETER MRI

RECESSED PATTERN

STATIC WHITE



Adjustable end sleeve - TES

Adjustable end sleeve (TES) is designed to provide on-site luminaire adjustability of +2.5" to -4.5". A sleeve accommodates an easy installation and maintenance. Please refer to the [End Sleeve Adjustment Installation Instructions](#) for more details.

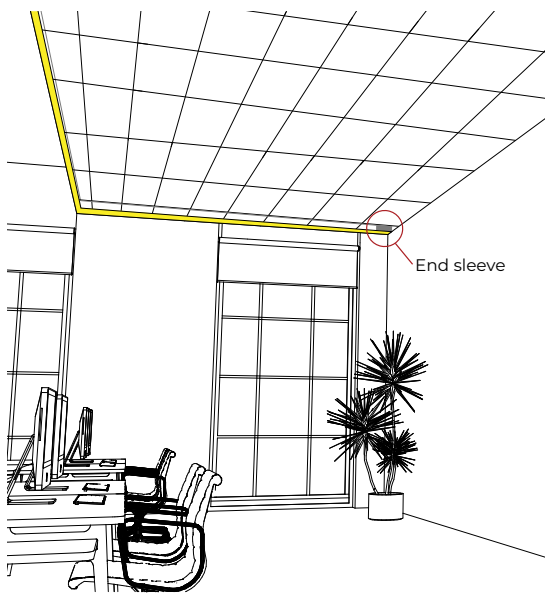

X = Fixture measure provided by client.
 X + 2.5" = Measurement built and supplied.

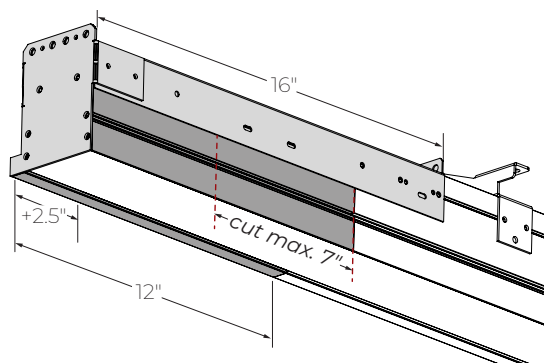
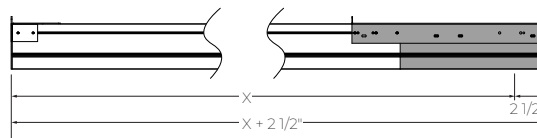

Adjustable mid sleeve - TMS

Adjustable mid sleeve (TMS) is designed to provide on-site luminaire adjustability of +2.5" to -4.5". A sleeve accommodates an easy installation and maintenance. Please refer to the [Mid Sleeve Adjustment Installation Instructions](#) for more details.

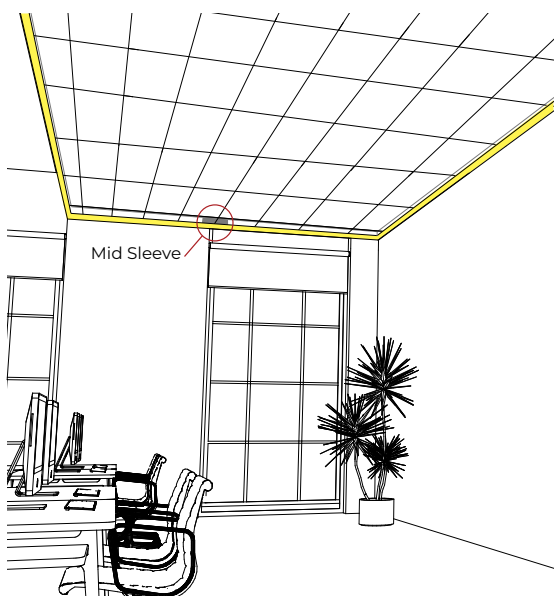

X = Fixture measure provided by client.
 X + 2.5" = Measurement built and supplied.

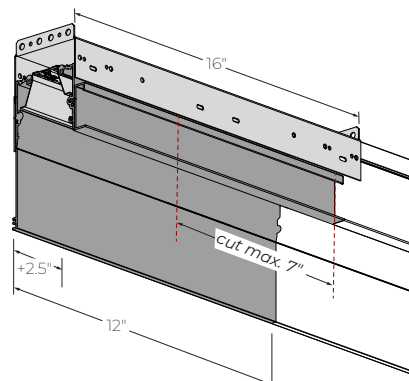
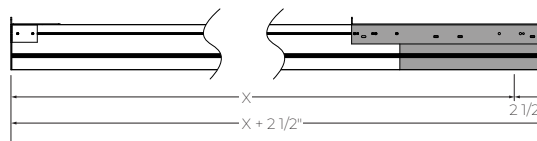

VIA 3 PERIMETER MRI

RECESSED PATTERN

STATIC WHITE



Technical Specifications

OPTICS

High-Efficiency Lambertian Optic (HLO)

The High-Efficiency Lambertian Optic (HLO) uses matte white reflectors to distribute LED output across 0.075" acrylic shielding, providing up to 88% transmission and good obscuration. Luminaire brightness is controlled by the flux-to-shielding area ratio.

Asymmetric Room Fill Optic (ARFO)

Our Asymmetric Room Fill Optic employs an advanced optical system to illuminate rooms and corridors from the perimeter, providing a direct distribution of light with precision and minimal glare.

LIGHT SOURCE

Custom linear array of mid-flux LEDs are cartridge-mounted with quick-connect wiring to facilitate service and thermal management. Available in 2700K, 3000K, 3500K, 4000K and 5000K with a minimum 80 CRI and an option for 90 CRI with elevated R9 value. Color consistency maintained to within 3 SDCM. LEDs operated at reduced drive current to optimize efficacy and lumen maintenance.

All LEDs have been tested in accordance with IESNA LM-80-08 and the results have shown L80 lumen maintenance greater than 60,000 hours. Absolute product photometry is measured and presented in accordance with IESNA LM-79, unless otherwise indicated.

PATTERN LENGTH

All individual sections are joined together onsite using the joiner kits provided. Lumenwerx offers joiner kits that are extremely simple to work with in the field and result in a fixture that appears virtually seamless with no light leak at any connection.

ELECTRICAL

Factory-set, adjustable output current LED driver with universal (120-277 VAC) input. Dimmable from 100% to 1% with 0-10V dimming control. Rated life (90% survivorship) of 50,000 hours at 50°C max. ambient (and 70°C max. case) temperature. At maximum driver load: Efficiency > 84%, PF > 0.9, THD < 20%. Other specifiable options include Lutron Hi-Lume 1% Eco, eldoLED 1% ECOdrive 0-10V, eldoLED 0.1% SOLOdrive 0-10V, and DALI protocol drivers. All of our standard 0-10V drivers are NEMA 410 compliant.

PoE

Depending on the PoE manufacturer selected, Lumenwerx will install the node in factory as either integral to the luminaire or as a remote module. Factory programming of the PoE node may or may not enable the following functionalities: lumen package, DUO (tunable white), QUADRO (RGBW), emergency battery backup, and sensor integration. These must be addressed and evaluated on a case-by-case basis.

ELECTRICAL SECTION OPTIONS

Electrical section options are available for fixtures specified as multi circuit (#MC). With MC, specify the total number of circuits (#), including any circuits required for optional electrical sections. A drawing is required to specify the layout. Please consult factory for custom configurations.

Electrical sections

Options include emergency-powered (#EC##), night light (#NL##), daylight (#DL##), and generator transfer device (#GTD##) sections. Specify the quantity (#), as well as the section length in inches (##).

Example 1: A 32' Direct fixture with two 8' emergency-powered sections on a second circuit.

Code: 2MC-2EC96

Example 2: A 24' Direct fixture with one 4' generator transfer device section.

Code: 1MC-1GTD48

Battery

Each emergency battery (#EMB) powers a 4' section. All batteries will be on the same circuit. Specify the number of batteries (#) required.

Factory installed long life, high temperature, maintenance-free Lithium-Ion battery pack with self-test functionality, test switch and charge indicator. Minimum of 90 minutes operation, up to 1000 lumens per 4' (25°C) emergency lighting output and recharge time of 24 hours.

MOUNTING

Recessed fixtures can be mounted into exposed or concealed T-bar or texture ceiling, as well as in drywall ceilings with trim, trimless, or mud flange options.

FINISH

Interior: 95%, reflective matte powder coated white paint

Exterior: Matte white powder coating.

Optional antimicrobial finish, as well as custom finishes, also available.

VIA 3 PERIMETER MRI

RECESSED PATTERN

STATIC WHITE



CONSTRUCTION

Housing: Extruded aluminum, up to 90% recycled content

Interior brackets: Die-formed cold rolled sheet aluminum

Joining system: Die-cast zinc

Reflectors: Flat rolled aluminum sheet or die-formed cold rolled aluminum, 95% reflective matte white painted

Lens: Acrylic

Recessed flanges: Extruded aluminum, up to 90% recycled content

End plate: Die-formed cold rolled sheet aluminum

CERTIFICATIONS

ETL: Rated for indoor dry/damp locations. Conforms to UL Standard 1598 and certified to CAN/CSA Standard C22.2 No. 250.0.

Chicago Plenum: City of Chicago Approved (CCEA) when specified with CP option.

IC rated: Suitable for direct contact with insulation

WARRANTY

Lumenwerx provides a five-year limited warranty of electrical and mechanical performance of the luminaires, including the LED boards, drivers, and auxiliary electronics. Lumenwerx will repair or replace defective luminaires or components at our discretion, provided they have been installed and operated in accordance with our specifications. Other limitations apply, please refer to the full warranty on our website.