

# VIA 3 PERIMETER MRI

## RECESSED

## STATIC WHITE



Project: \_\_\_\_\_

Type: \_\_\_\_\_



Via 3 Perimeter Deep

### DESCRIPTION

Via Perimeter MRI fixtures are designed specifically for MRI suites in healthcare applications and constructed with non-ferrous materials. With remote drivers, they create a continuously illuminated "slot" at the wall/ceiling intersection. Lighted corners with adjustable end sleeves are available. Via Perimeter installs in grid or drywall ceilings in a choice of three arrangements: level, shallow 1", and deep 3 1/4". An additional antimicrobial finish option is available.



SENSORS  
For latest information on sensors, click [here](#).



IC RATED

Up to 121 lm/W performance

## Order Guide

LUMINAIRE ID	OPTIC	LIGHT SOURCE <sup>2</sup>	CRI	LUMEN PACKAGE	COLOR TEMP.
		<b>SW</b>			
<b>V3PERMRIL</b> - Via 3 Perimeter MRI Level <b>V3PERMRIS</b> - Via 3 Perimeter MRI Shallow <b>V3PERMRID</b> - Via 3 Perimeter MRI Deep	<b>HLO</b> - High-Efficiency Lambertian Optic <b>ARFO</b> <sup>1</sup> - Asymmetric Room Fill Optic  <sup>1</sup> Not available with Deep fixtures.	<b>SW</b> - Static white  <sup>2</sup> Chromawerx SOLA, DUO and QUADRO also available. Consult factory.	<b>80CRI</b> - 80 CRI <b>90CRI</b> - 90 CRI	<b>500LMF</b> - Low output 500 lm/ft <b>750LMF</b> - Medium output 750 lm/ft <b>1000LMF</b> - High output 1000 lm/ft	<b>27K</b> - 2700K <b>30K</b> - 3000K <b>35K</b> - 3500K <b>40K</b> - 4000K <b>50K</b> - 5000K

LUMINAIRE LENGTH	VOLTAGE	REMOTE DRIVER <sup>4,5</sup>	ELECTRICAL	ELECTRICAL SECTIONS (optional) <sup>10,11</sup>
<b>#FT#IN</b> - Specify nominal length (#) in 1' and/or 1" increments  <b>Standard nominal lengths:</b> Single units: 2' to 12' Continuous runs: lengths over 12'	<b>120V</b> - 120V <b>277V</b> - 277V <b>UNV</b> - 120V-277V <b>347V</b> <sup>3</sup> - 347V  <sup>3</sup> Only available with RD1 driver.	<b>RD1</b> - 1% 0-10V <b>RDA</b> <sup>6</sup> - DALI <b>RLDE1</b> <sup>6</sup> - Lutron Hi-lume 1% Eco <b>RELD1</b> - eldoLED 1% ECOdrive 0-10V <b>RELD0</b> - eldoLED 0.1% SOLOdrive 0-10V  <sup>4</sup> PoE (Power-over-Ethernet) compatible. Consult factory for details. <sup>5</sup> A remote driver box is provided. <sup>6</sup> On-site commissioning is required.	<b>IC</b> - 1 circuit <b>#MC</b> <sup>7</sup> - Multi circuit <b>EC</b> - Emergency-powered fixture <b>NL</b> - Night light fixture <b>DL</b> - Daylight fixture <b>GTD</b> <sup>8,9</sup> - Generator transfer device fixture  <sup>7</sup> Specify total number of circuits (#), including any required for electrical section options. Provide drawing or layout specifications. Minimum 4' section per circuit. <sup>8</sup> Minimum 4' fixture. <sup>9</sup> Not available with 347V.	<b>#EC##</b> <sup>12</sup> - Emergency-powered section <b>#NL##</b> <sup>12</sup> - Night light section <b>#DL##</b> <sup>12</sup> - Daylight section <b>#GTD##</b> <sup>12,13,14</sup> - Generator transfer device section <b>#EMB</b> <sup>14,15</sup> - Emergency battery <b>NA</b> - None  <sup>10</sup> Specify with multi circuit (#MC) electrical option only. <sup>11</sup> Provide drawing or layout specifications. Consult factory for other configurations. Default section length is 4'. <sup>12</sup> Specify quantity (#), and section length in inches (##). <sup>13</sup> Minimum 4' section. <sup>14</sup> Not available with 347V. <sup>15</sup> Specify quantity (#). All batteries will be on the same circuit. Each battery powers a 4' section.

MOUNTING	FINISH	OPTIONS <sup>16</sup>	ADJUSTABLE SLEEVE (optional) <sup>18</sup>
<b>TC9</b> - Tegular 9/16" <b>TC15</b> - Tegular 15/16" <b>TB9</b> - T-bar 9/16" <b>TB15</b> - T-bar 15/16" <b>ST</b> - Screw slot T-bar <b>DTR</b> - Drywall trim <b>DTL</b> - Drywall trimless <b>DMF</b> - Drywall mud flange	<b>W</b> - Matte white <b>WA</b> - White antimicrobial Silverwerx <b>CF#</b> - Custom finish, specify RAL#	<b>NEF</b> <sup>17</sup> - No end flanges <b>FU120</b> - Fuse 120V <b>FU277</b> - Fuse 277V <b>FWC</b> - Flexible whip cable (6' std) <b>CP</b> - Chicago Plenum <b>NA</b> - None  <sup>16</sup> Separate codes with a "*" if more than one is specified. <sup>17</sup> For wall-to-wall installations.	<b>TES</b> <sup>19</sup> - Adjustable end sleeve <b>NA</b> - None  <sup>18</sup> See page 3 for details. <sup>19</sup> Minimum 3' fixture for UNV/D1 driver. Minimum 4' fixture for all other drivers. Minimum 5' fixture with EMB option.

TECHZONE™ & USG Compatible with 4" ceiling

3737 Cote Vertu St-Laurent, Quebec, Canada H4R 2C9  
T (514) 225-4304 F (514) 931-4862  
[www.lumenwerx.com](http://www.lumenwerx.com)



Lumenwerx reserves the right to modify product specifications without notification.  
© Lumenwerx, ULC. All rights reserved.

VIA3-PERIMETER-MRI-SPEC-REV0.5 February 23, 2026



# VIA 3 PERIMETER MRI

RECESSED  
STATIC WHITE



## Dimensions

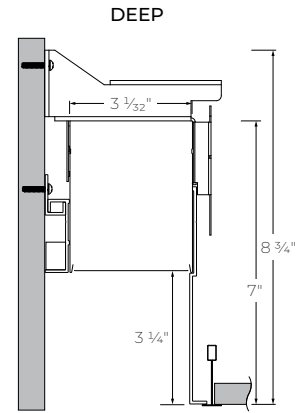
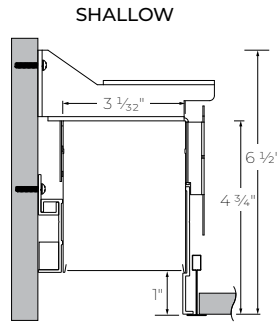
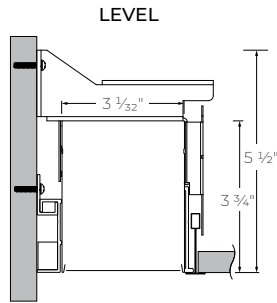

## DRYWALL

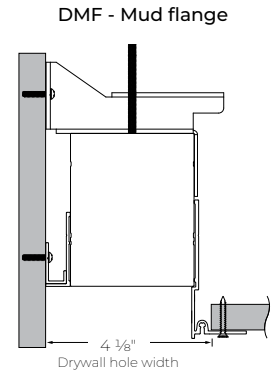
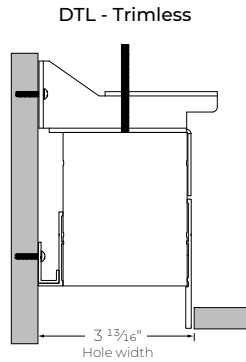
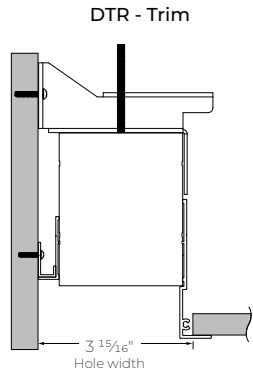

## GRID

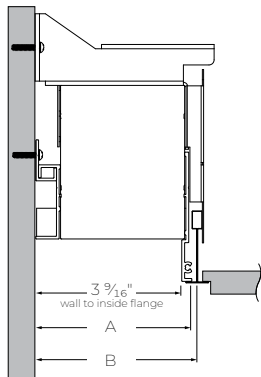

	TC9	TB9	TC15	TB15	ST
	Tegular 9/16"	T-bar 9/16"	Tegular 15/16"	T-bar 15/16"	Screw slot T-bar
A wall to flange	3 13/16"		3 15/16"		3 13/16"
B wall to T-bar	3 7/8"		4"		3 7/8"

# VIA 3 PERIMETER MRI

## RECESSED

### STATIC WHITE



## Photometrics

Values calculated based on a 4' fixture at 3500K and 80 CRI for all optics.

HLO

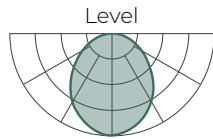

LM/FT	W/FT	LM/W
500	4.1	121
750	6.4	117
1000	8.8	114

ARFO

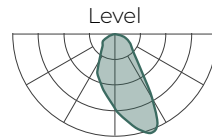

LM/FT	W/FT	LM/W
500	5.5	91
750	8.8	85
1000	12.4	81

Shallow

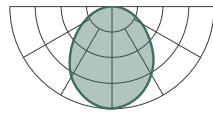

LM/FT	W/FT	LM/W
500	4.2	118
750	6.5	115
1000	9	111

Shallow

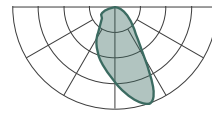

LM/FT	W/FT	LM/W
500	5.6	89
750	8.9	84
1000	12.5	80

Deep

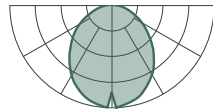

LM/FT	W/FT	LM/W
500	4.4	113
750	6.9	109
1000	9.5	105

### MULTIPLIER TABLE

Use this table to get results for different color temperatures and CRI for all photometric tables.

### Multiplier - CCT/CRI

CCT	WATTS		LPW	
	80 CRI	90 CRI	80 CRI	90 CRI
2700K	1.05	1.27	0.95	0.79
3000K	1.02	1.23	0.98	0.81
3500K	1.00	1.19	1.00	0.84
4000K	1.00	1.19	1.04	0.84
5000K	0.96	1.12	1.00	0.89

## Adjustable end sleeve - TES

Adjustable end sleeve (TES) is designed to provide on-site luminaire adjustability of +2.5" to -4.5". A sleeve accommodates an easy installation and maintenance. Please refer to the [End Sleeve Adjustment Installation Instructions](#) for more details.

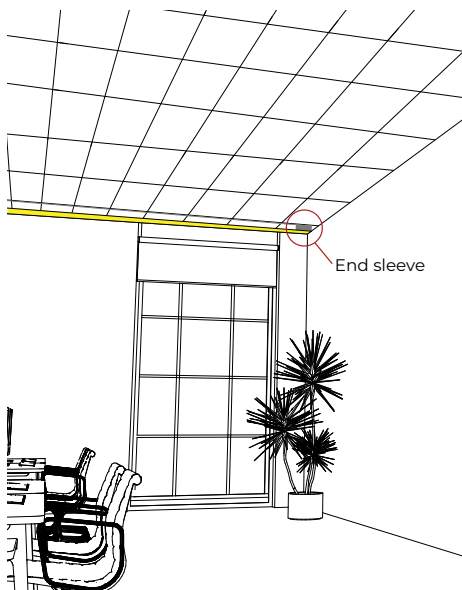

X = Fixture measure provided by client.  
X + 2.5" = Measurement built and supplied.

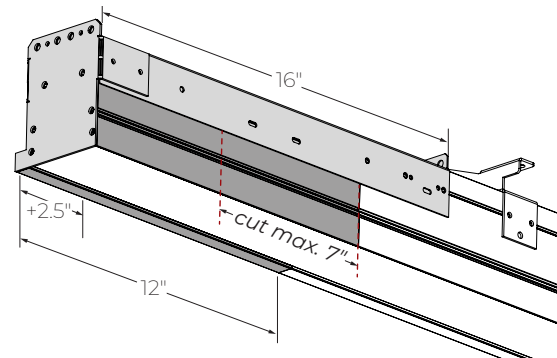
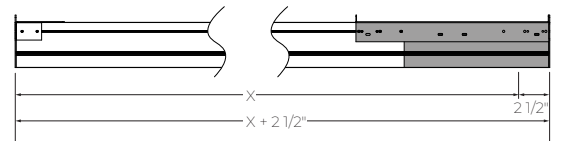

# VIA 3 PERIMETER MRI

## RECESSED

### STATIC WHITE



## Technical Specifications

### OPTICS

#### High-Efficiency Lambertian Optic (HLO)

The High-Efficiency Lambertian Optic (HLO) uses matte white reflectors to distribute LED output across 0.075" acrylic shielding, providing up to 88% transmission and good obscuration. Luminaire brightness is controlled by the flux-to-shielding area ratio.

#### Asymmetric Room Fill Optic (ARFO)

Our Asymmetric Room Fill Optic employs an advanced optical system to illuminate rooms and corridors from the perimeter, providing a direct distribution of light with precision and minimal glare.

### LIGHT SOURCE

Custom linear array of mid-flux LEDs are cartridge-mounted with quick-connect wiring to facilitate service and thermal management. Available in 2700K, 3000K, 3500K, 4000K and 5000K with a minimum 80 CRI and an option for 90 CRI with elevated R9 value. Color consistency maintained to within 3 SDCM. LEDs operated at reduced drive current to optimize efficacy and lumen maintenance.

All LEDs have been tested in accordance with IESNA LM-80-08 and the results have shown L80 lumen maintenance greater than 60,000 hours. Absolute product photometry is measured and presented in accordance with IESNA LM-79, unless otherwise indicated.

### LUMINAIRE LENGTH

Via 3 Perimeter is made up of standard 2' to 12' sections that may be joined together to create longer continuous run lengths. Exact run lengths must be noted in the product code. The minimum individual section available is 2'.

All individual sections are joined together onsite using the joiner kits provided. Lumenwerx offers joiner kits that are extremely simple to work with in the field and result in a fixture that appears virtually seamless with no light leak at any connection.

### ELECTRICAL

Factory-set, adjustable output current LED driver with universal (120-277 VAC) input. Dimmable from 100% to 1% with 0-10V dimming control. Rated life (90% survivorship) of 50,000 hours at 50°C max. ambient (and 70°C max. case) temperature. At maximum driver load: Efficiency > 84%, PF > 0.9, THD < 20%. Other specifiable options include Lutron Hi-Lume 1% Eco, eLdoLED 1% ECOdrive 0-10V, eLdoLED 0.1% SOLOdrive 0-10V, and DALI protocol drivers. All of our standard 0-10V drivers are NEMA 410 compliant.

### PoE

Depending on the PoE manufacturer selected, Lumenwerx will install the node in factory as either integral to the luminaire or as a remote module. Factory programming of the PoE node may or may not enable the following functionalities: lumen package, DUO (tunable white), QUADRO (RGBW), emergency battery backup, and sensor integration. These must be addressed and evaluated on a case-by-case basis.

### ELECTRICAL SECTION OPTIONS

Electrical section options are available for fixtures specified as multi circuit (#MC). With MC, specify the total number of circuits (#), including any circuits required for optional electrical sections. A drawing is required to specify the layout. Please consult factory for custom configurations.

### Electrical sections

Options include emergency-powered (#EC##), night light (#NL##), daylight (#DL##), and generator transfer device (#GTD##) sections. Specify the quantity (#), as well as the section length in inches (##).

Example 1: A 32' Direct fixture with two 8' emergency-powered sections on a second circuit.

Code: 2MC-2EC96

Example 2: A 24' Direct fixture with one 4' generator transfer device section.

Code: 1MC-1GTD48

### Battery

Each emergency battery (#EMB) powers a 4' section. All batteries will be on the same circuit. Specify the number of batteries (#) required.

Factory installed long life, high temperature, maintenance-free Lithium-Ion battery pack with self-test functionality, test switch and charge indicator. Minimum of 90 minutes operation, up to 1000 lumens per 4' (25°C) emergency lighting output and recharge time of 24 hours.

### MOUNTING

Recessed fixtures can be mounted into exposed or concealed T-bar or tegular ceiling, as well as in drywall ceilings with trim, trimless, or mud flange options.

### FINISH

**Interior:** 95%, reflective matte powder coated white paint

**Exterior:** Matte white powder coating.

Optional antimicrobial finish, as well as custom finishes, also available.

# VIA 3 PERIMETER MRI

## RECESSED

### STATIC WHITE



#### CONSTRUCTION

**Housing:** Extruded aluminum, up to 90% recycled content

**Interior brackets:** Die-formed cold rolled sheet aluminum

**Joining system:** Die-cast zinc

**Reflectors:** Flat rolled aluminum sheet or die-formed cold rolled aluminum, 95% reflective matte white painted

**Lens:** Acrylic

**Recessed flanges:** Extruded aluminum, up to 90% recycled content

**End plate:** Die-formed cold rolled sheet aluminum

#### WEIGHT

**4':** 11.12 lbs - 5.05 kg

**8':** 22.25 lbs - 10.1 kg

**12':** 33.48 lbs - 15.2 kg

#### CERTIFICATIONS

**ETL:** Rated for indoor dry/damp locations. Conforms to UL Standard 1598 and certified to CAN/CSA Standard C22.2 No. 250.0.

**Chicago Plenum:** City of Chicago Approved (CCEA) when specified with CP option.

**IC rated:** Suitable for direct contact with insulation

#### WARRANTY

Lumenwerx provides a five-year limited warranty of electrical and mechanical performance of the luminaires, including the LED boards, drivers, and auxiliary electronics. Lumenwerx will repair or replace defective luminaires or components at our discretion, provided they have been installed and operated in accordance with our specifications. Other limitations apply, please refer to the full warranty on our website.