

VIA 3 PERIMETER

RECESSED PATTERN

STATIC WHITE



Project: _____

Type: _____

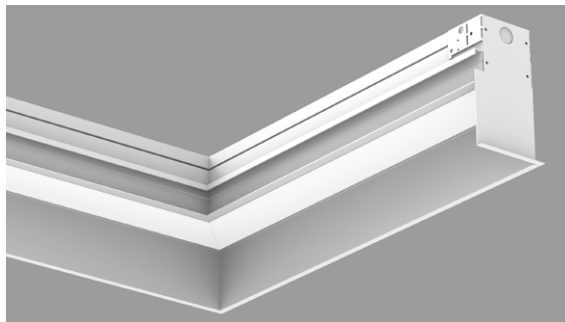

Via 3 Perimeter Deep Pattern

DESCRIPTION

Via 3 Perimeter creates a continuously illuminated "slot" at the wall/ceiling intersection. Lighted corners with adjustable end sleeves are available. Via Perimeter installs in grid or drywall ceilings in a choice of three arrangements: level, shallow 1", and deep 3 1/4".

Declare.
IC RATED



SENSORS
For latest information on sensors, click [here](#).

Up to 121 lm/W performance

Order Guide

► A drawing of your pattern is required - anything from a line drawing to an architectural drawing.

LUMINAIRE ID	OPTIC	LIGHT SOURCE	CRI	LUMEN PACKAGE	COLOR TEMP.	PATTERN LENGTH
		SW				
V3PERLPAT - Via 3 Perimeter Level Pattern V3PERSPAT - Via 3 Perimeter Shallow Pattern V3PERDPAT - Via 3 Perimeter Deep Pattern	HLO - High-Efficiency Lambertian Optic ARFO ¹ - Asymmetric Room Fill Optic ¹ Not available with Deep fixtures.	SW - Static white	80CRI - 80+ CRI 90CRI - 90+ CRI	500LMF - Low output 500 lm/ft 750LMF - Medium output 750 lm/ft 1000LMF - High output 1000 lm/ft	27K - 2700K 30K - 3000K 35K - 3500K 40K - 4000K 50K - 5000K	##FT##IN(##FT##IN-##FT##IN-...) ² - ##FT##IN: total nominal length of pattern in feet and/or inches #: quantity of each section #FT##IN: nominal length of each section in feet and/or inches Continuous runs: lengths over 12' ² Minimum fixture length is 4'.
CORNER TYPE ³	VOLTAGE	DRIVER ⁷	ELECTRICAL	ELECTRICAL SECTIONS (optional) ^{13,14}		
#LEV12C(A##) - 2-way leveled inside corner #LEVO2C(A##) ⁴ - 2-way leveled outside corner ³ Specify quantity (#) and angle (A##) for each required corner type. If more than one option is specified, separate codes with a "+", e.g. 1LEV12C(A90)+2LEVO2C(A90). ⁴ Not available with ARFO. ⁵ Minimum angle is 45°.	ANGLE (A##): (A90) - 90° (A##) ^{4,5} - Custom	120V - 120V 277V - 277V UNV - 120V-277V 347V ⁶ - 347V ⁶ Available with D1 driver only.	D1 - 1% 0-10V ELV ⁸ - ELV 120V TRI ⁸ - TRIAC 120V DA ⁹ - DALI LDE1 ⁹ - Lutron Hi-lume 1% Eco ELDI - eldoLED 1% ECOdrive 0-10V ELDO - eldoLED 0.1% SOLOdrive 0-10V ⁷ PoE (Power-over-Ethernet) compatible. Consult factory for details. ⁸ Available with 120V only. ⁹ On-site commissioning is required.	1C - 1 circuit #MC ¹⁰ - Multi circuit EC - Emergency-powered fixture NL - Night light fixture DL - Daylight fixture CTD ^{11,12} - Generator transfer device fixture ¹⁰ Specify total number of circuits (#), including any required for electrical section options. Provide drawing or layout specifications. Minimum 4' section per circuit. ¹¹ Minimum 4' fixture. ¹² Not available with 347V.	#EC## ¹⁵ - Emergency-powered section #NL## ¹⁵ - Night light section #DL## ¹⁵ - Daylight section #GTD## ^{15,16,17} - Generator transfer device section #EMB ^{17,18} - Emergency battery NA - None ¹³ Specify with multi circuit (#MC) electrical option only. ¹⁴ Provide drawing or layout specifications. Consult factory for other configurations. Default section length is 4'. ¹⁵ Specify quantity (#), and section length in inches (##). ¹⁶ Minimum 4' section. ¹⁷ Not available with 347V. ¹⁸ Specify quantity (#). All batteries will be on the same circuit. Each battery powers a 4' section.	
MOUNTING	FINISH	CONTROL ¹⁹	CONNECTED CONTROLS ²³	OPTIONS ²⁴	ADJUSTABLE SLEEVE (optional) ²⁷	
TG9 - Regular 9/16" TG15 - Regular 15/16" TB9 - T-bar 9/16" TB15 - T-bar 15/16" ST - Screw slot T-bar DTR - Trim DTL - Trimless DMF - Drywall mud flange	W - Matte white CF# - Custom finish, specify RAL#	STANDALONE CONTROLS ^{20,21,22} Specify the quantity (#) of sensors per fixture. #ODS - Onboard Daylight	LU - Lutron AWN - Lutron Athena Wireless Node RF Only AWNS - Lutron Athena Wireless Node Sensor ENC - Encelium WL - Cooper Wavelinx AN - Acuity nLight CA - Casambi LG - Legrand NA - None	NEF ^{25,26} - No end flanges FEP ²⁶ - Flush end plates FU120 - Fuse 120V FU277 - Fuse 277V FWC - Flexible whip cable (6' std) CP - Chicago Plenum NA - None ²⁴ Separate codes with a "+" if more than one is specified. ²⁵ For wall-to-wall installations. ²⁶ See page 4 for details.	#TES ²⁸ - Adjustable end sleeve, specify quantity (#) #TMS ²⁹ - Adjustable mid sleeve, specify quantity (#) NA - None ²⁷ See page 5 for details. ²⁸ Minimum 5' fixture with EMB option. ²⁹ Minimum 6' fixture. Maximum 1 sleeve per section.	
		¹⁹ Standalone and connected control options cannot be combined. ²⁰ Not available with Shallow or Deep fixtures. ²¹ Available with D1 driver and 1 circuit options only. ²² Minimum 4' per zone. Provide control zone length. ²³ Consult factory for connected controls.				

TECHZONE™ & USG Compatible with 4" ceiling

3737 Cote Vertu St-Laurent, Quebec, Canada H4R 2C9
 T (514) 225-4304 F (514) 931-4862
www.lumenwerx.com



Lumenwerx reserves the right to modify product specifications without notification.
 © Lumenwerx, U.L.C. All rights reserved.



VIA3-PERIMETER-PATTERN-SPEC-REV5 October 16, 2025

VIA 3 PERIMETER

RECESSED PATTERN

STATIC WHITE



Dimensions

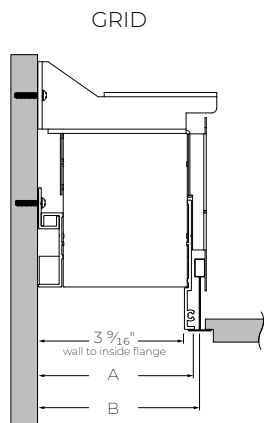
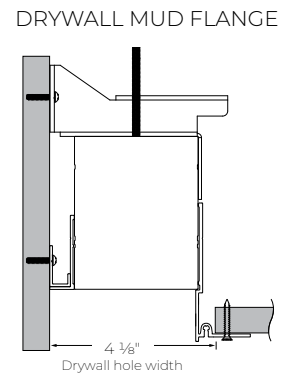
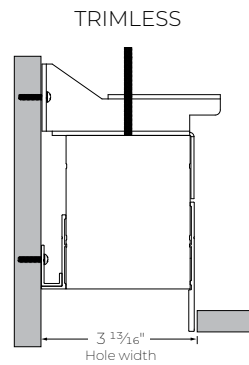
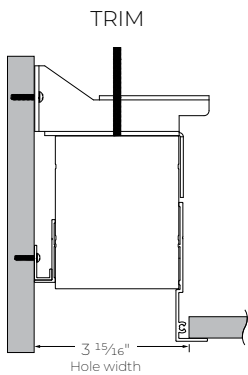
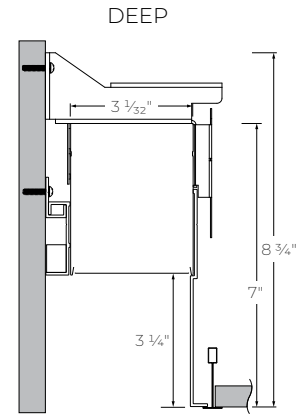
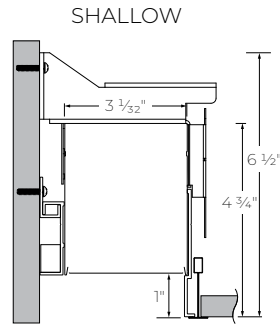
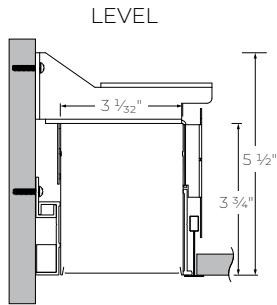

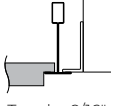
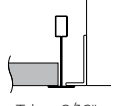
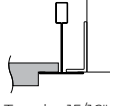
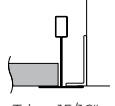
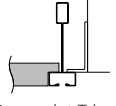
	TC9  Tegular 9/16"	TB9  T-bar 9/16"	TG15  Tegular 15/16"	TB15  T-bar 15/16"	ST  Screw slot T-bar
A wall to flange	3 13/16"		3 15/16"		3 13/16"
B wall to T-bar	3 7/8"		4"		3 7/8"

VIA 3 PERIMETER

RECESSED PATTERN

STATIC WHITE



Photometrics

Values calculated based on a 4' fixture at 3500K for all optics.

HLO

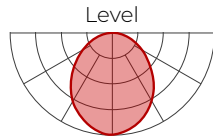

LM/FT	W/FT	LM/W
500	4.1	121
750	6.4	117
1000	8.8	114

ARFO

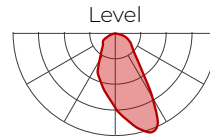

LM/FT	W/FT	LM/W
500	5.5	91
750	8.8	85
1000	12.4	81

Shallow

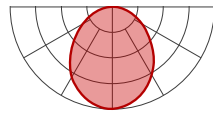

LM/FT	W/FT	LM/W
500	4.2	118
750	6.5	115
1000	9	111

Shallow

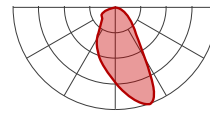

LM/FT	W/FT	LM/W
500	5.6	89
750	8.9	84
1000	12.5	80

Deep

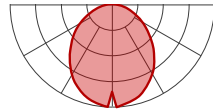

LM/FT	W/FT	LM/W
500	4.4	113
750	6.9	109
1000	9.5	105

MULTIPLIER TABLE

Use this table to get results for different color temperatures for all photometric tables.

Multiplier - CCT/CRI

CCT	WATTS	LPW
	80+ CRI / 90+ CRI	80+ CRI / 90+ CRI
2700K	1.05	0.95
3000K	1.02	0.98
3500K	1.00	1.00
4000K	1.00	1.00
5000K	0.96	1.04

VIA 3 PERIMETER

RECESSED PATTERN

STATIC WHITE



Pattern Layout

CORNER TYPES

LEVELED INSIDE CORNER

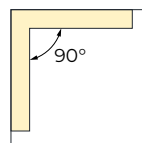

1LEVI2C(90)

LEVELED OUTSIDE CORNER

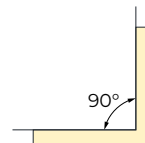

1LEVO2C(90)

2-way

EXAMPLES

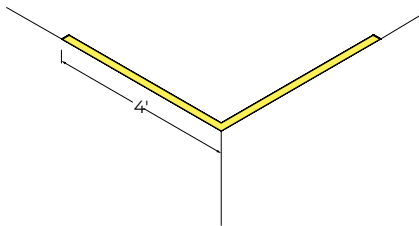

8FT(2X4FT)-1LEVI2C(90)

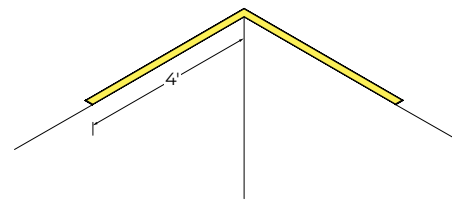

8FT(2X4FT)-1LEVO2C(90)

End Configurations

STANDARD

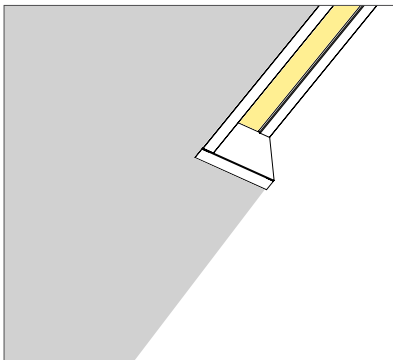

OPTIONS

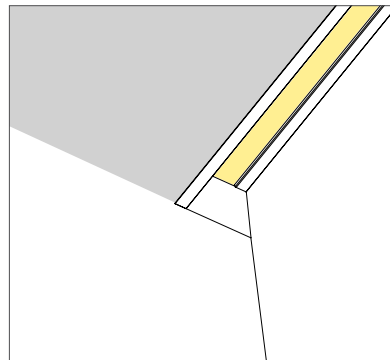

NEF - No end flanges

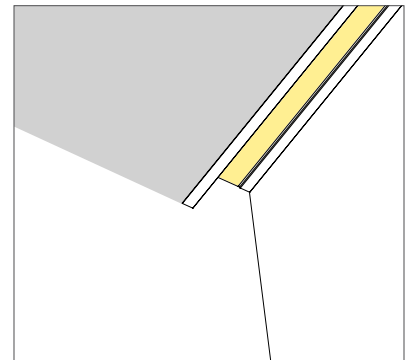

FEP - Flush end plates

VIA 3 PERIMETER

RECESSED PATTERN

STATIC WHITE



Adjustable End Sleeve - TES

Adjustable end sleeve (TES) is designed to provide on-site luminaire adjustability of +2.5" to -4.5". A sleeve accommodates an easy installation and maintenance. Please refer to the [End Sleeve Adjustment Installation Instructions](#) for more details.

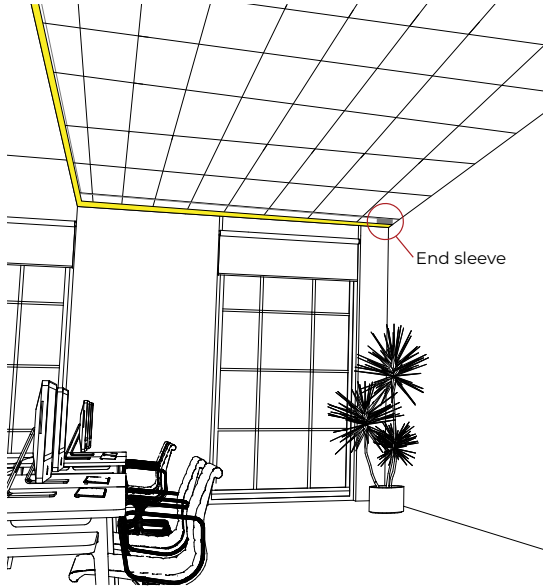

X = Fixture measure provided by client.
X + 2.5" = Measurement built and supplied.

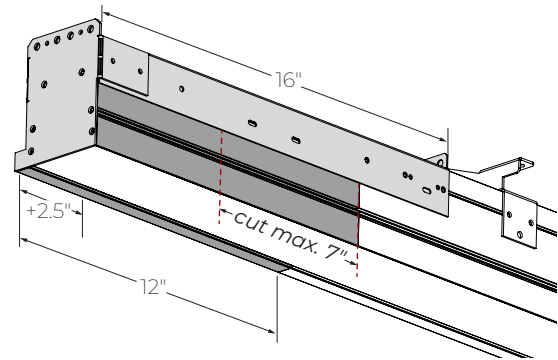
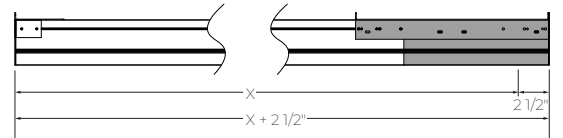

Adjustable Mid Sleeve - TMS

Adjustable mid sleeve (TMS) is designed to provide on-site luminaire adjustability of +2.5" to -4.5". A sleeve accommodates an easy installation and maintenance. Please refer to the [Mid Sleeve Adjustment Installation Instructions](#) for more details.

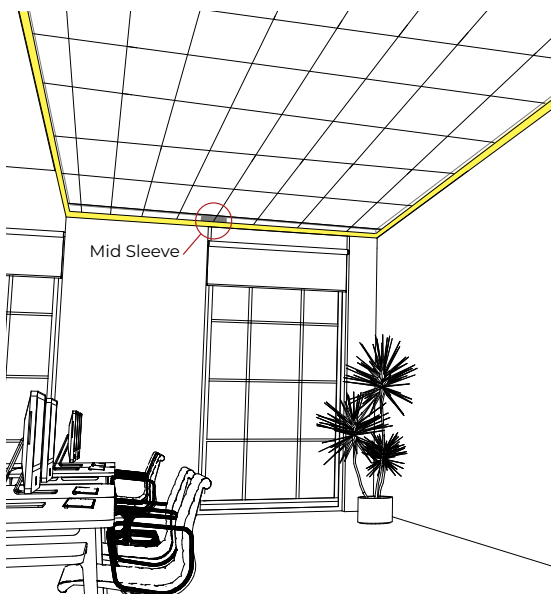

X = Fixture measure provided by client.
X + 2.5" = Measurement built and supplied.

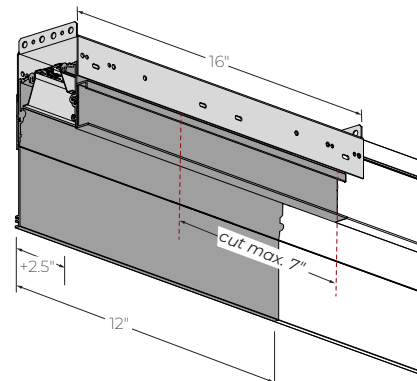
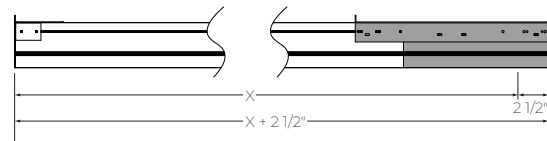

VIA 3 PERIMETER

RECESSED PATTERN

STATIC WHITE



Technical Specifications

OPTICS

High-Efficiency Lambertian Optic (HLO)

The High-Efficiency Lambertian Optic (HLO) uses matte white reflectors to distribute LED output across 0.075" acrylic shielding, providing up to 88% transmission and good obscuration. Luminaire brightness is controlled by the flux-to-shielding area ratio.

Asymmetric Room Fill Optic (ARFO)

Our Asymmetric Room Fill Optic employs an advanced optical system to illuminate rooms and corridors from the perimeter, providing a direct distribution of light with precision and minimal glare.

LIGHT SOURCE

Custom linear array of mid-flux LEDs are cartridge-mounted with quick-connect wiring to facilitate service and thermal management. Available in 2700K, 3000K, 3500K, 4000K and 5000K with a minimum 80+ CRI and an option for 90+ CRI with elevated R9 value. Color consistency maintained to within 3 SDCM. LEDs operated at reduced drive current to optimize efficacy and lumen maintenance.

All LEDs have been tested in accordance with IESNA LM-80-08 and the results have shown L80 lumen maintenance greater than 60,000 hours. Absolute product photometry is measured and presented in accordance with IESNA LM-79, unless otherwise indicated.

PATTERN LENGTH

All individual sections are joined together onsite using the joiner kits provided. Lumenwerx offers joiner kits that are extremely simple to work with in the field and result in a fixture that appears virtually seamless with no light leak at any connection.

ELECTRICAL

Factory-set, adjustable output current LED driver with universal (120-277 VAC) input. Dimmable from 100% to 1% with 0-10V dimming control. Rated life (90% survivorship) of 50,000 hours at 50°C max. ambient (and 70°C max. case) temperature. At maximum driver load: Efficiency > 84%, PF > 0.9, THD < 20%. Other specifiable options include Lutron Hi-Lume 1% Eco, eldoLED 1% ECOdrive 0-10V, eldoLED 0.1% SOLOdrive 0-10V, and DALI protocol drivers. All of our standard 0-10V drivers are NEMA 410 compliant. ELV and TRIAC dimming performance (including minimum dimming percentage) subject to dimmer selection.

PoE

Depending on the PoE manufacturer selected, Lumenwerx will install the node in factory as either integral to the luminaire or as a remote module. Factory programming of the PoE node may or may not enable the following functionalities: lumen package, DUO (tunable white), QUADRO (RGBW), emergency battery backup, and sensor integration. These must be addressed and evaluated on a case-by-case basis.

ELECTRICAL SECTION OPTIONS

Electrical section options are available for fixtures specified as multi circuit (#MC). With MC, specify the total number of circuits (#), including any circuits required for optional electrical sections. A drawing is required to specify the layout. Please consult factory for custom configurations.

Electrical sections

Options include emergency-powered (#EC##), night light (#NL##), daylight (#DL##), and generator transfer device (#GTD##) sections. Specify the quantity (#), as well as the section length in inches (##).

Example 1: A 32' Direct fixture with two 8' emergency-powered sections on a second circuit.

Code: 2MC-2EC96

Example 2: A 24' Direct fixture with one 4' generator transfer device section.

Code: 1MC-1GTD48

Battery

Each emergency battery (#EMB) powers a 4' section. All batteries will be on the same circuit. Specify the number of batteries (#) required.

Factory installed long life, high temperature, maintenance-free Lithium-Ion battery pack with self-test functionality, test switch and charge indicator. Minimum of 90 minutes operation, up to 1000 lumens per 4' (25°C) emergency lighting output and recharge time of 24 hours.

MOUNTING

Recessed fixtures can be mounted into exposed or concealed T-bar or regular ceiling, as well as in ceilings with trim, trimless, or mud flange options.

FINISH

Interior: 95%, reflective matte powder coated white paint

Exterior: Matte white powder coating.

Custom finishes are also available.



VIA 3 PERIMETER

RECESSED PATTERN

STATIC WHITE



CONTROLS

Lumenwerx offers several options for integrating occupancy and daylight harvesting controls in our luminaires.

For latest information on sensors, click [here](#).



Standalone controls

An integrated standalone sensor controls the luminaire in which it is installed. Depending on the length, more than one sensor may be necessary and may control the entire luminaire, or just a section of it. These controls operate independently. Unless otherwise agreed, location and functionality of the sensor within the luminaire are selected by Lumenwerx. See client drawings for details.

One type is available:

ODS: An integral, daylight harvesting sensor with closed-loop operation dims the luminaire in which it is installed in order to compensate for available daylight. The sensor measures the combination of daylight and luminaire light reflected from horizontal surfaces below the luminaire. Initial onsite calibration is required via the use of provided remote control.

Connected controls

With connected controls, sensors or nodes installed in the luminaire form part of a larger control system infrastructure from manufacturers such as: Lutron, Encelium, Cooper Wavelinx, Acuity nLight, Casambi, Legrand, and others. These connected controls allow for a scalable system providing features like occupancy and daylight control, manual control, scheduling and configuration of various zones and scenes. Energy reporting and system monitoring are also possible. Specific capabilities depend on the control system being used.

Lumenwerx installs the components (sensors, nodes, power packs, etc) which may be supplied to us by a third party, or procured directly by Lumenwerx, depending on the control system manufacturer.

Lumenwerx is solely responsible for the installation of specified components; the controls manufacturer is responsible for performance of the control system.

To indicate a Lumenwerx luminaire with connected controls, identify the specific onsite control system to be integrated into the luminaires using the ordering code. Due to the diversity of components, you must contact factory to assure complete compatibility with intended control system and to fully specify the luminaire.

Complete control specifications, sensor/node/power pack layout, and narrative for the control system are required for Lumenwerx to create shop drawings and submittals.

CONSTRUCTION

Housing: Extruded aluminum, up to 90% recycled content

Interior brackets: Die-formed cold rolled sheet steel

Joining system: Die-cast zinc

Reflectors: Flat rolled aluminum sheet or die-formed cold rolled steel, 95% reflective matte white painted

Lens: Acrylic

Recessed flanges: Extruded aluminum, up to 90% recycled content

End plate: Die-formed cold rolled sheet steel

MAINTENANCE

LED boards are housed in a removable cartridge for easy replacement. Driver is accessible from below.

CERTIFICATIONS

ETL: Rated for indoor dry/damp locations. Conforms to UL Standard 1598 and certified to CAN/CSA Standard C22.2 No. 250.0.

Chicago Plenum: City of Chicago Approved (CCEA) when specified with CP option.

IC rated: Suitable for direct contact with insulation

Declare: [LBC Red List Approved](#)

WARRANTY

Lumenwerx provides a five-year limited warranty on electrical and mechanical performance of the luminaires, including the LED boards, drivers, and auxiliary electronics. Lumenwerx will repair or replace defective luminaires or components at our discretion, provided they have been installed and operated in accordance with our specifications. Other limitations apply, please refer to the full warranty on our website.