

VIA 3 PERIMETER

RECESSED PATTERN

CHROMAWERX - QUADRO - RGBW



Project: _____

Type: _____

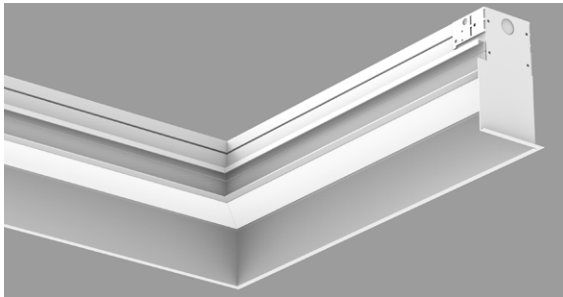

Via 3 Perimeter Deep Pattern

DESCRIPTION

Via 3 Perimeter creates a continuously illuminated "slot" at the wall/ceiling intersection. Lighted corners with adjustable end sleeves are available. Via Perimeter installs in grid or drywall ceilings in a choice of three arrangements: level, shallow 1", and deep 3 3/4".

Declare.
IC RATED



Order Guide

► A drawing of your pattern is required - anything from a line drawing to an architectural drawing.

LUMINAIRE ID	OPTIC	LIGHT SOURCE ²	WHITE CRI Specify NA for solid colors	OUTPUT WATTAGE ³	
V3PERLPAT - Via 3 Perimeter Level Pattern V3PERSPAT - Via 3 Perimeter Shallow Pattern V3PERDPAT - Via 3 Perimeter Deep Pattern	HLO - High-Efficiency Lambertian Optic ARFO ¹ - Asymmetric Room Fill Optic ¹ Not available with Deep fixtures.	QUADRO - RGBW 4-channel control RS - Red solid GS - Green solid BS - Blue solid ² Static white, Chromawerx SOLA and DUO also available. Consult other spec sheets.	80CRI - 80+ CRI 90CRI - 90+ CRI NA - Not applicable	8WF - 8 W/ft output 10WF ⁴ - 10 W/ft output 12WF ⁴ - 12 W/ft output ³ See page 3 for dedicated white channel lumen outputs. ⁴ Not available with solid colors.	
WHITE COLOR TEMP. Specify NA for solid colors	PATTERN LENGTH	CORNER TYPE ⁶		VOLTAGE	
27K - 2700K 30K - 3000K 35K - 3500K 40K - 4000K 50K - 5000K NA - Not applicable	##FT##IN(##X##FT##IN-##X##FT##IN-...) ⁵ - ##FT##IN: total nominal length of pattern in feet and/or inches ##X: quantity of each section #FT##IN: nominal length of each section in feet and/or inches Continuous runs: lengths over 12' ⁵ Minimum fixture length is 4'.	#LEVI2C(A##) - 2-way leveled inside corner #LEVO2C(A##) ⁷ - 2-way leveled outside corner ⁶ Specify quantity (#) and angle (A##) for each required corner type. If more than one option is specified, separate codes with a "+", e.g. 1LEVI2C(A90)+2LEVO2C(A90). ⁷ Not available with ARFO. ⁸ Minimum angle is 45°.	ANGLE (A##): (A90) - 90° (A##) ^{7,8} - Custom	120V - 120V 277V - 277V UNV - 120V-277V	
DRIVER ⁹	ELECTRICAL	MOUNTING	FINISH	OPTIONS ¹²	ADJUSTABLE SLEEVE (optional) ¹⁵
QUADRO DMX ^{10,11} - DMX ⁹ PoE (Power-over-Ethernet) compatible. Consult factory for details. ¹⁰ For more information, see pages 8 to 13. ¹¹ On-site commissioning is required.	IC - 1 circuit	TC9 - Tegular 9/16" TC15 - Tegular 15/16" TB9 - T-bar 9/16" TB15 - T-bar 15/16" ST - Screw slot T-bar DTR - Trim DTL - Trimless DMF - Drywall mud flange	W - Matte white CF# - Custom finish, specify RAL#	NEF ^{13,14} - No end flanges FEP ¹⁴ - Flush end plates FU120 - Fuse 120V FU277 - Fuse 277V FWC - Flexible whip cable (6' std) CP - Chicago Plenum NA - None ¹² Separate codes with a "+" if more than one is specified. ¹³ For wall-to-wall installations. ¹⁴ See page 4 for details.	#TES - Adjustable end sleeve, specify quantity (#) #TMS ¹⁶ - Adjustable mid sleeve, specify quantity (#) NA - None ¹⁵ See page 5 for details. ¹⁶ Minimum 6' fixture. Maximum 1 sleeve per section.

Accessories

Optional, order separately

DMX WALL CONTROLLER ^{17,18}

WC1W##FT - Single zone wall controller white
WC1B##FT - Single zone wall controller black
WC2W##FT - 3 zone wall controller white
WC2B##FT - 3 zone wall controller black

¹⁷ Specify wire length (##) in feet.

¹⁸ Available with DMX only. For more information, see pages 8 to 13, or consult factory.

TECHZONE™ & USG Compatible with 4" ceiling

3737 Cote Vertu St-Laurent, Quebec, Canada H4R 2C9
 T (514) 225-4304 F (514) 931-4862

www.lumenwerx.com



Lumenwerx reserves the right to modify product specifications without notification.

© Lumenwerx, ULC. All rights reserved.

VIA3-PERIMETER-RGBW-PATTERN-SPEC-REV2 October 16, 2025



VIA 3 PERIMETER

RECESSED PATTERN

CHROMAWERX - QUADRO - RGBW



Dimensions

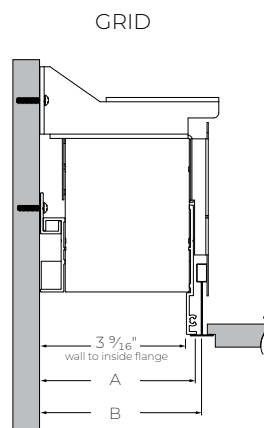
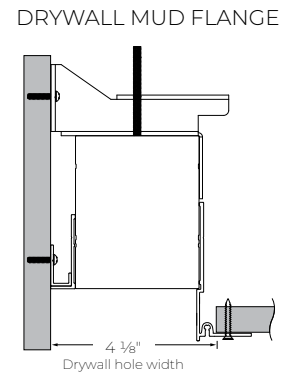
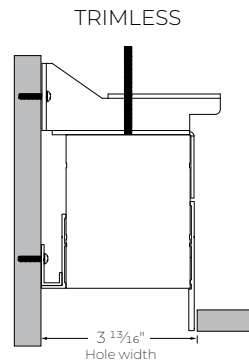
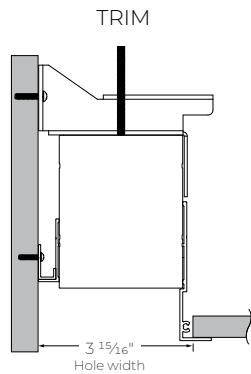
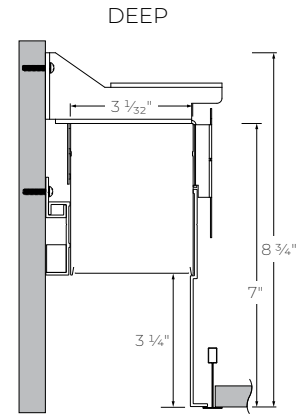
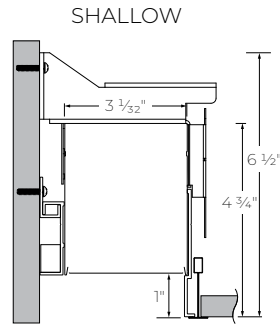
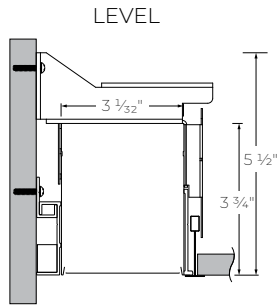

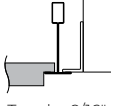
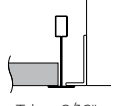
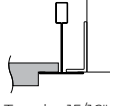
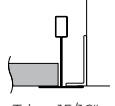
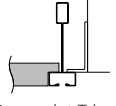
	TC9  Tegular 9/16"	TB9  T-bar 9/16"	TG15  Tegular 15/16"	TB15  T-bar 15/16"	ST  Screw slot T-bar
A wall to flange	3 13/16"	3 13/16"	3 15/16"	3 13/16"	3 13/16"
B wall to T-bar	3 7/8"	3 7/8"	4"	3 7/8"	3 7/8"

VIA 3 PERIMETER

RECESSED PATTERN

CHROMAWERX - QUADRO - RGBW



Pattern Layout

CORNER TYPES

LEVELED INSIDE CORNER

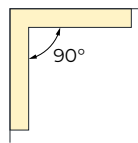

1LEVI2C(90)

LEVELED OUTSIDE CORNER

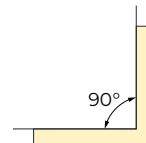

1LEVO2C(90)

2-way

EXAMPLES

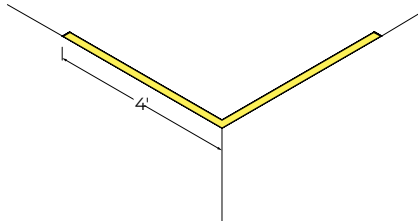

8FT(2X4FT)-1LEVI2C(90)

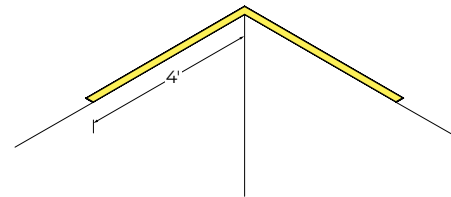

8FT(2X4FT)-1LEVO2C(90)

Photometrics

Dedicated white channel lumen outputs are calculated with only white light on, and based on a 4' fixture at 3500K.

OPTIC	W/FT	LM/FT
HLO - Level	8	350
	10	425
	12	525
HLO - Shallow	8	350
	10	425
	12	500
HLO - Deep	8	325
	10	400
	12	475

OPTIC	W/FT	LM/FT
ARFO - Level	8	160
	10	200
	12	240
ARFO - Shallow	8	150
	10	190
	12	230

VIA 3 PERIMETER

RECESSED PATTERN

CHROMAWERX - QUADRO - RGBW



End Configurations

STANDARD

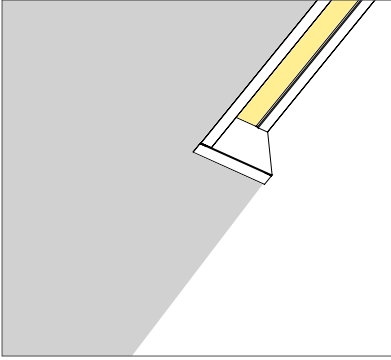

OPTIONS

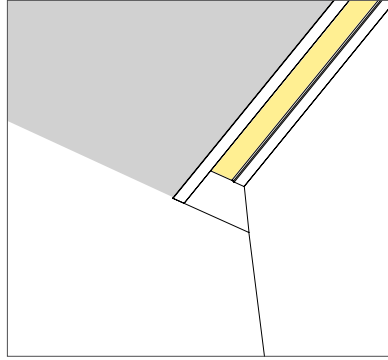

NEF - No end flanges

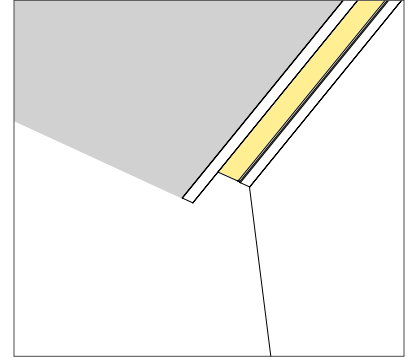

FEP - Flush end plates

VIA 3 PERIMETER

RECESSED PATTERN

CHROMAWERX - QUADRO - RGBW



Adjustable End Sleeve - TES

Adjustable end sleeve (TES) is designed to provide on-site luminaire adjustability of +2.5" to -4.5". A sleeve accommodates an easy installation and maintenance. Please refer to the [End Sleeve Adjustment Installation Instructions](#) for more details.

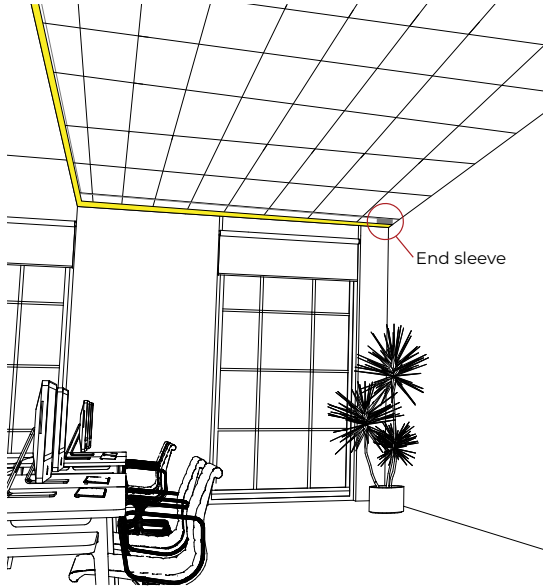

X = Fixture measure provided by client.
X + 2.5" = Measurement built and supplied.

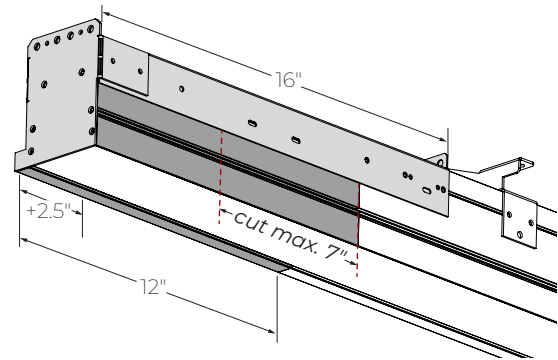
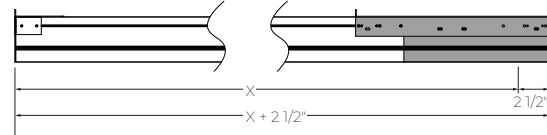

Adjustable Mid Sleeve - TMS

Adjustable mid sleeve (TMS) is designed to provide on-site luminaire adjustability of +2.5" to -4.5". A sleeve accommodates an easy installation and maintenance. Please refer to the [Mid Sleeve Adjustment Installation Instructions](#) for more details.

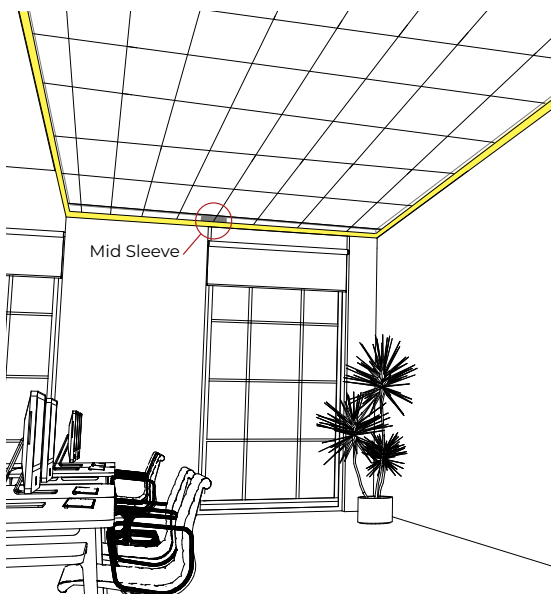

X = Fixture measure provided by client.
X + 2.5" = Measurement built and supplied.

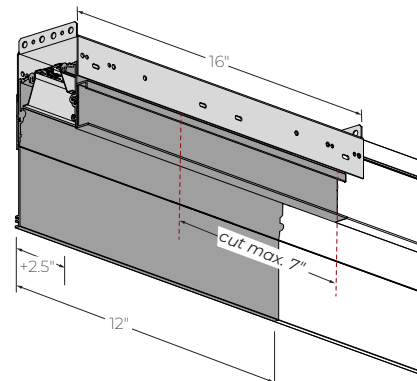
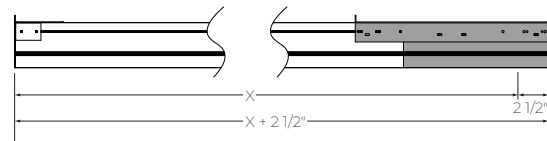

VIA 3 PERIMETER

RECESSED PATTERN

CHROMAWERX - QUADRO - RGBW



Technical Specifications

OPTICS

High-Efficiency Lambertian Optic (HLO)

The High-Efficiency Lambertian Optic (HLO) uses matte white reflectors to distribute LED output across 0.075" acrylic shielding, providing up to 88% transmission and good obscuration. Luminaire brightness is controlled by the flux-to-shielding area ratio.

Asymmetric Room Fill Optic (ARFO)

Our Asymmetric Room Fill Optic employs an advanced optical system to illuminate rooms and corridors from the perimeter, providing a direct distribution of light with precision and minimal glare.

LIGHT SOURCE

Custom linear array of mid-flux LEDs, comprised of an alternation of an RGB and a dedicated white LED. The white LED is used for when a static white CCT is required in the space. RGB LEDs are tightly binned for excellent color control between fixtures. The white LEDs have been tested in accordance with IESNA LM-80-08 and the results have shown L80 lumen maintenance greater than 60,000 hours. Absolute product photometry is measured and presented in accordance with IESNA LM-79, unless otherwise indicated.

Chromawerx QUADRO

Chromawerx QUADRO is a four-channel control that operates an RGBW LED array and addresses the need for more expressive color in architectural applications. The DMX driver supports familiar programming tools for both dynamic multi-hued color and precise white color point control. While a typical user interface will be a DMX controller by others, Lumenwerx also offers a simple control station for stand-alone color changing applications.

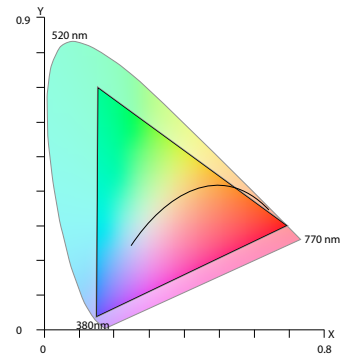

The above diagram overlays the full gamut of colors attainable with the RGBW on top of the CIE 1931 color space. Any color point inside of the triangle can be obtained by setting the correct output levels for each of the individual red, green, blue, and white channels.

PATTERN LENGTH

All individual sections are joined together onsite using the joiner kits provided. Lumenwerx offers joiner kits that are extremely simple to work with in the field and result in a fixture that appears virtually seamless with no light leak at any connection.

ELECTRICAL

DMX

Factory-set, adjustable output current, multi-channel LED driver with universal (120-277 VAC) input. Using DMX wall controls (optionally supplied by Lumenwerx) or an existing DMX control system, four channels of LEDs (Red/Green/Blue/White) are independently adjustable. Each DMX driver has multiple output channels that can be independently addressed at the factory or on-site using built-in RDM (Remote Device Management) functionality. Dimming range from 100%-0%. At maximum driver load, efficiency<89%, PF>0.9, THD<20%.

PoE

Depending on the PoE manufacturer selected, Lumenwerx will install the node in factory as either integral to the luminaire or as a remote module. Factory programming of the PoE node may or may not enable the following functionalities: lumen package, DUO (tunable white), QUADRO (RGBW), emergency battery backup, and sensor integration. These must be addressed and evaluated on a case-by-case basis.

MOUNTING

Recessed fixtures can be mounted into exposed or concealed T-bar or tegular ceiling, as well as in ceilings with trim, trimless, or mud flange options.

VIA 3 PERIMETER

RECESSED PATTERN

CHROMAWERX - QUADRO - RGBW



FINISH

Interior: 95%, reflective matte powder coated white paint

Exterior: Matte white powder coating.

Custom finishes are also available.

CONSTRUCTION

Housing: Extruded aluminum, up to 90% recycled content

Interior brackets: Die-formed cold rolled sheet steel

Joining system: Die-cast zinc

Reflectors: Flat rolled aluminum sheet or die-formed cold rolled steel, 95% reflective matte white painted

Lens: Acrylic

Recessed flanges: Extruded aluminum, up to 90% recycled content

End plate: Die-formed cold rolled sheet steel

MAINTENANCE

LED boards are housed in a removable cartridge for easy replacement. Driver is accessible from below.

CERTIFICATIONS

ETL: Rated for indoor dry/damp locations. Conforms to UL Standard 1598 and certified to CAN/CSA Standard C22.2 No. 250.0.

Chicago Plenum: City of Chicago Approved (CCEA) when specified with CP option.

IC rated: Suitable for direct contact with insulation

Declare: [LBC Red List Approved](#)

WARRANTY

Lumenwerx provides a five-year limited warranty on electrical and mechanical performance of the luminaires, including the LED boards, drivers, and auxiliary electronics. Lumenwerx will repair or replace defective luminaires or components at our discretion, provided they have been installed and operated in accordance with our specifications. Other limitations apply, please refer to the full warranty on our website.

Wall controllers are covered by the manufacturer warranty.

VIA 3 PERIMETER

RECESSED PATTERN

CHROMAWERX - QUADRO - RGBW



QUADRO DMX SPECIFICATION

A qualified DMX integrator is required to assure proper installation and commissioning of the DMX network. **When placing the PO, please provide the contact information of your DMX integrator.**

Please answer the following questions to help us identify your DMX network requirements.

YES

Do you require a wall controller provided by Lumenwerx?

NO

DMX control system supplied by others. Lumenwerx will supply DMX-enabled fixtures with default DMX addressing. See following pages for technical DMX informations. ✓

DMX controller supplied by Lumenwerx

How many zones do you have?
A zone consists of one or more luminaires behaving identically.



1 Zone



2 Zones

How to calculate the required number of drivers:

per 4' fixture

Driver
 1x driver
 Less than 12.5W/ft, direct only

per 4' fixture

Driver Driver
 2x driver
 Above 12.5W/ft or for all direct/indirect fixture

To Calculate # of drivers

1 Zone

2 to 3 Zones

4 or more Zones

Do you have more than 32 drivers in total?

NO

YES

Order a standard Lumenwerx wall controller type 1.

WALL CONTROLLER

WC1W - Single zone wall controller white
WC1B - Single zone wall controller black

Add the control code at the end of your order code. Please provide a fixture layout or RCP (Reflected Ceiling Plan) showing the locations of the DMX fixtures, zones and the DMX wall controller. Refer to your DMX integrator for the installation. ✓

Subject to factory evaluation. Please contact our controls specialist at controls@lumenwerx.com. Additional cost and equipment will be required. ✓

NO

YES

Order a standard Lumenwerx wall controller type 2.

WALL CONTROLLER

WC2W - 3 zone wall controller white
WC2B - 3 zone wall controller black

Add the control code at the end of your order code. Please provide a fixture layout or RCP (Reflected Ceiling Plan) showing the locations of the DMX fixtures, zones and the DMX wall controller. Refer to your DMX integrator for the installation. ✓

Subject to factory evaluation. Please contact our controls specialist at controls@lumenwerx.com. Additional cost and equipment will be required. ✓

Subject to factory evaluation and approval. Please contact our controls specialist at controls@lumenwerx.com. Additional cost and equipment will be required. ✓

VIA 3 PERIMETER

RECESSED PATTERN

CHROMAWERX - QUADRO - RGBW



GENERIC DMX NETWORK ARCHITECTURE

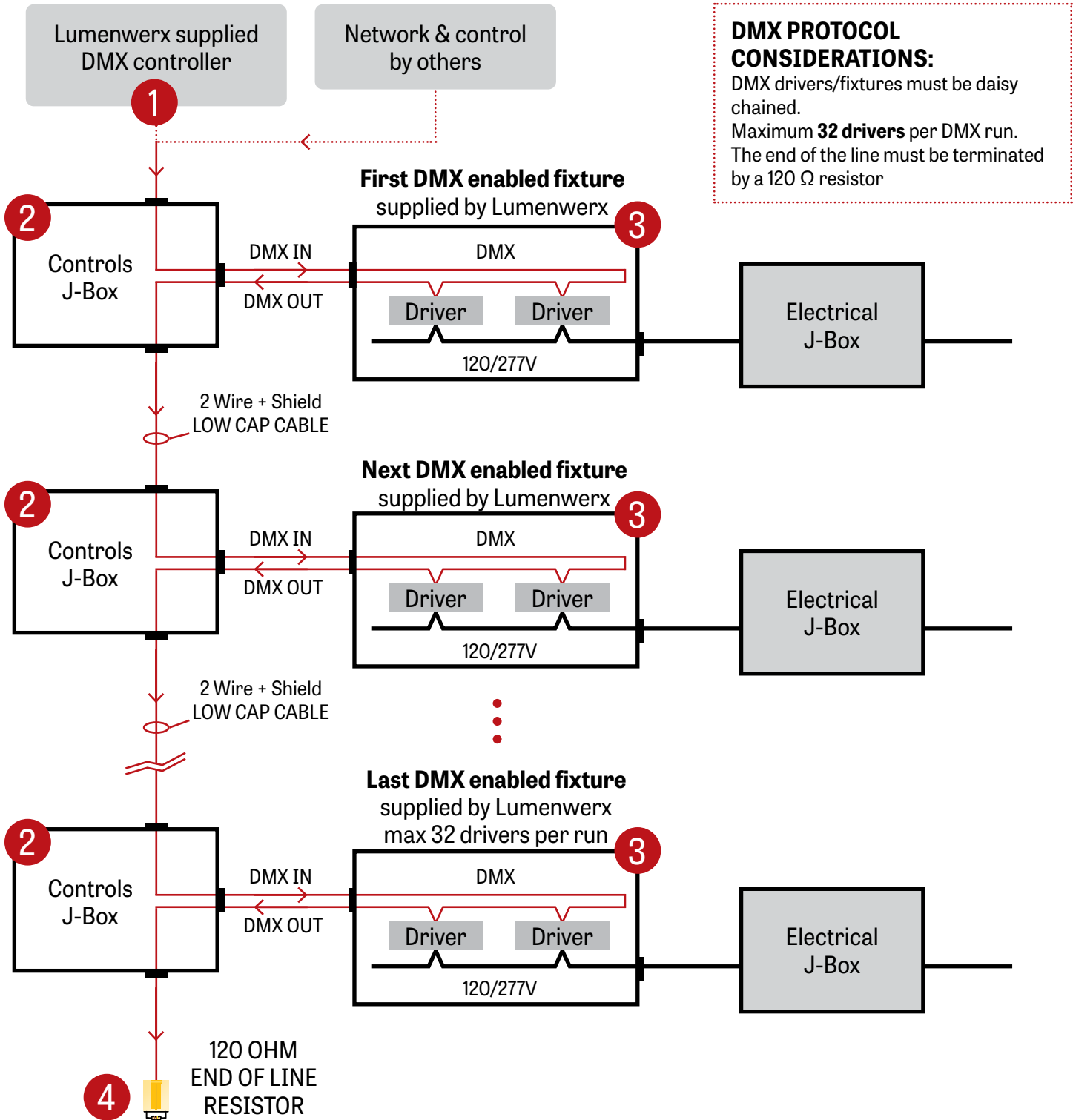

DMX PROTOCOL CONSIDERATIONS:
 DMX drivers/fixtures must be daisy chained.
 Maximum **32 drivers** per DMX run.
 The end of the line must be terminated by a 120 Ω resistor

VIA 3 PERIMETER

RECESSED PATTERN

CHROMAWERX - QUADRO - RGBW



1 LUMENWERX SUPPLIED DMX CONTROLLER

To the first fixture

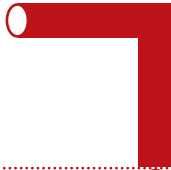

2 Wire +
Shield Low Cap Cable

WALL BOX SUPPLIED BY OTHERS

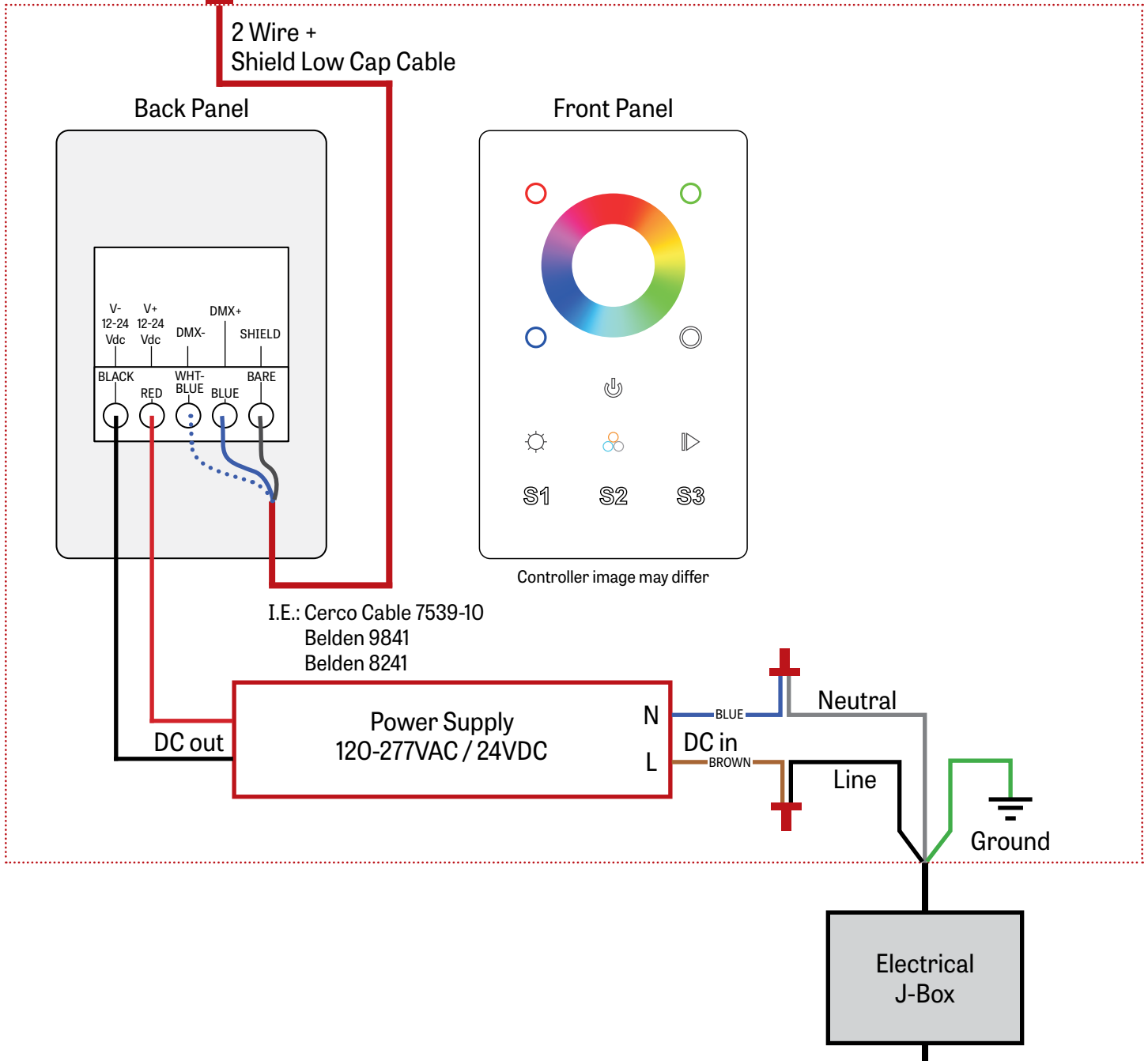

VIA 3 PERIMETER

RECESSED PATTERN

CHROMAWERX - QUADRO - RGBW



4 DMX LAST FIXTURE DETAIL

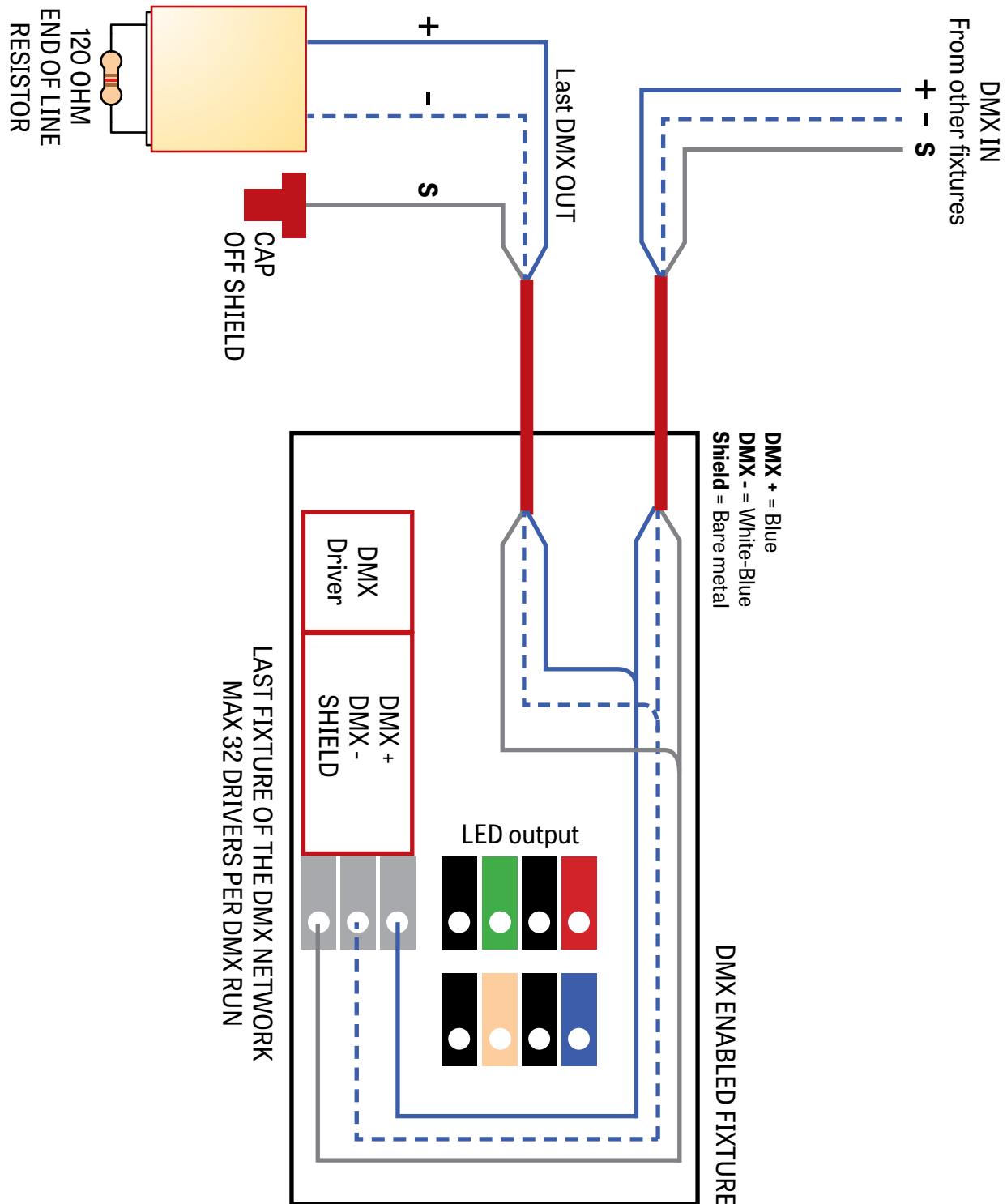

VIA 3 PERIMETER

RECESSED PATTERN

CHROMAWERX - QUADRO - RGBW



DMX WALL CONTROLLER

WC1

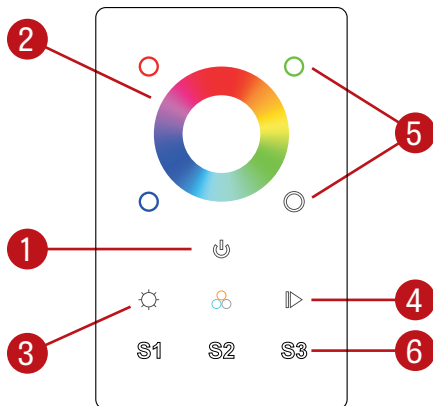

- (1) Power: Use this button to turn ON or OFF the RGBW fixture.
- (2) Color Wheel: The wheel is used to rapidly select a color (RGB colors only).
- (3) Brightness (RGB): Hold down this button to either increase or decrease the brightness of the current RGB selection. White will not be affected by the RGB brightness button.
- (4) Color Cycle: This button will start an animation, rotating between Reds Greens and Blues, the arrows allow the user to speed up or slow down the animation.
- (5) Individual Colors: By pressing and holding a color it will be possible to brighten or dim it. Quickly pressing a color will turn it OFF or turn it ON to its previous dim level.
White: In order to activate or deactivate and dim the White channel, the White button needs to be used.
- (6) Scenes: By holding down one of the scenes button, the current color selection is saved. It can be later accessed by quickly pressing on one of the Scene buttons.

WC2

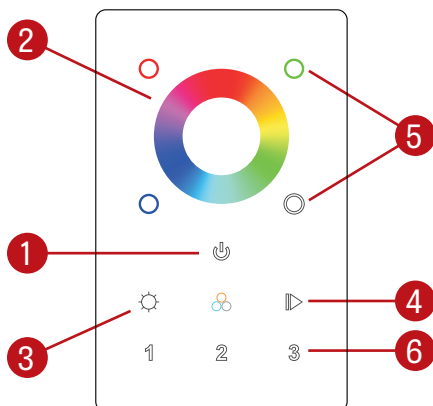

- (1) Power: Use this button to turn ON or OFF the RGBW fixture.
- (2) Color Wheel: The wheel is used to rapidly select a color (RGB colors only).
- (3) Brightness: Hold down this button to either increase or decrease the brightness of the current RGB selection. White will not be affected by the RGB brightness button.
- (4) Color Cycle: This button will start an animation, rotating between Reds Greens and Blues, the arrows allow the user to speed up or slow down the animation.
- (5) Individual Colors: By pressing a color it will be possible to brighten or dim that specific color.
White: In order to activate or deactivate and dim the White channel, the White button needs to be used.
- (6) Zone: By holding down one of the zone buttons, a zone can be selected and controlled.

Default DMX Addresses:

- 1 Red
- 2 Green
- 3 Blue
- 4 White