

# VIA 3 PERIMETER

RECESSED  
STATIC WHITE



Project: \_\_\_\_\_

Type: \_\_\_\_\_



Via 3 Perimeter Deep

## DESCRIPTION

Via 3 Perimeter creates a continuously illuminated "slot" at the wall/ceiling intersection. Lighted corners with adjustable end sleeves are available. Via Perimeter installs in grid or drywall ceilings in a choice of three arrangements: level, shallow 1", and deep 3 1/4".

Declare.



**SENSORS**  
For latest information on sensors, click [here](#).



IC RATED

Up to 121 lm/W performance

## Order Guide

LUMINAIRE ID	OPTIC	LIGHT SOURCE	CRI	LUMEN PACKAGE	COLOR TEMP.
		<b>SW</b>			
<b>V3PERL</b> - Via 3 Perimeter Level <b>V3PERS</b> - Via 3 Perimeter Shallow <b>V3PERD</b> - Via 3 Perimeter Deep	<b>HLO</b> - High-Efficiency Lambertian Optic <b>ARFO</b> <sup>1</sup> - Asymmetric Room Fill Optic <b>MPO</b> - Micro-Prismatic Optic  <sup>1</sup> Not available with Deep fixtures.	<b>SW</b> - Static white	<b>80CRI</b> - 80+ CRI <b>90CRI</b> - 90+ CRI	<b>500LMF</b> - Low output 500 lm/ft <b>750LMF</b> - Medium output 750 lm/ft <b>1000LMF</b> - High output 1000 lm/ft	<b>27K</b> - 2700K <b>30K</b> - 3000K <b>35K</b> - 3500K <b>40K</b> - 4000K <b>50K</b> - 5000K

LUMINAIRE LENGTH	VOLTAGE	DRIVER <sup>3</sup>	ELECTRICAL	ELECTRICAL SECTIONS (optional) <sup>9,10</sup>	MOUNTING
<b>#FT#IN</b> - Specify nominal length (#) in 1' and/or 1" increments  <b>Standard nominal lengths:</b> Single units: 2' to 12' (up to 8' for MPO) Continuous runs: lengths over 12' (8' for MPO)	<b>120V</b> - 120V <b>277V</b> - 277V <b>UNV</b> - 120V-277V <b>347V</b> <sup>2</sup> - 347V  <sup>2</sup> Available with D1 driver only.	<b>D1</b> - 1% 0-10V <b>ELV</b> <sup>4</sup> - ELV 120V <b>TRI</b> <sup>4</sup> - TRIAC 120V <b>DA</b> <sup>5</sup> - DALI <b>LDE1</b> <sup>5</sup> - Lutron Hi-lume 1% Eco <b>ELD1</b> - eldoLED 1% ECOdrive 0-10V <b>ELD0</b> - eldoLED 0.1% SOLOdrive 0-10V  <sup>3</sup> PoE (Power-over-Ethernet) compatible. Consult factory for details. <sup>4</sup> Available with 120V only. <sup>5</sup> On-site commissioning is required.	<b>1C</b> - 1 circuit <b>#MC</b> <sup>6</sup> - Multi circuit <b>EC</b> - Emergency-powered fixture <b>NL</b> - Night light fixture <b>DL</b> - Daylight fixture <b>GTD</b> <sup>7,8</sup> - Generator transfer device fixture  <sup>6</sup> Specify total number of circuits (#), including any required for electrical section options. Provide drawing or layout specifications. Minimum 4' section per circuit. <sup>7</sup> Minimum 4' fixture. <sup>8</sup> Not available with 347V.	<b>#EC##</b> <sup>11</sup> - Emergency-powered section <b>#NL##</b> <sup>11</sup> - Night light section <b>#DL##</b> <sup>11</sup> - Daylight section <b>#GTD##</b> <sup>11,12,13</sup> - Generator transfer device section <b>#EMB</b> <sup>13,14</sup> - Emergency battery <b>NA</b> - None  <sup>9</sup> Specify with multi circuit (#MC) electrical option only. <sup>10</sup> Provide drawing or layout specifications. Consult factory for other configurations. Default section length is 4'. <sup>11</sup> Specify quantity (#), and section length in inches (##). <sup>12</sup> Minimum 4' section. <sup>13</sup> Not available with 347V. <sup>14</sup> Specify quantity (#). All batteries will be on the same circuit. Each battery powers a 4' section.	<b>TG9</b> - Regular 9/16" <b>TG15</b> - Regular 15/16" <b>TB9</b> - T-bar 9/16" <b>TB15</b> - T-bar 15/16" <b>ST</b> - Screw slot T-bar <b>DTR</b> - Trim <b>DTL</b> - Trimless <b>DMF</b> - Drywall mud flange

FINISH	CONTROL <sup>15</sup>	OPTIONS <sup>20</sup>	ADJUSTABLE SLEEVE (optional) <sup>23</sup>
<b>W</b> - Matte white <b>CF#</b> - Custom finish, specify RAL#	<b>STANDALONE CONTROLS</b> <sup>16,17,18</sup> Specify the quantity (#) of sensors per fixture. <b>#ODS</b> - Onboard Daylight  <b>CONNECTED CONTROLS</b> <sup>19</sup> <b>LU</b> - Lutron <b>AWNR</b> - Lutron Athena Wireless Node RF Only <b>AWNS</b> - Lutron Athena Wireless Node Sensor <b>ENC</b> - Encielum <b>WL</b> - Cooper Wavelinx <b>AN</b> - Acuity nLight <b>CA</b> - Casambi <b>LG</b> - Legrand  <b>NA</b> - None  <sup>15</sup> Standalone and connected control options cannot be combined. <sup>16</sup> Not available with Shallow or Deep fixtures. <sup>17</sup> Available with D1 driver and 1 circuit options only. <sup>18</sup> Minimum 4' per zone. Provide control zone length. <sup>19</sup> Consult factory for connected controls.	<b>NEF</b> <sup>21,22</sup> - No end flanges <b>FEP</b> <sup>22</sup> - Flush end plates <b>FU120</b> - Fuse 120V <b>FU277</b> - Fuse 277V <b>FWC</b> - Flexible whip cable (6' std) <b>CP</b> - Chicago Plenum <b>NA</b> - None  <sup>20</sup> Separate codes with a "*" if more than one is specified. <sup>21</sup> For wall-to-wall installations. <sup>22</sup> See page 4 for details.	<b>TES</b> <sup>24</sup> - Adjustable end sleeve <b>NA</b> - None  <sup>23</sup> See page 4 for details. <sup>24</sup> Minimum 3' fixture for UNV/D1 driver. Minimum 4' fixture for all other drivers. Minimum 5' fixture with EMB option.

TECHZONE™ & USG Compatible with 4" ceiling

3737 Cote Vertu St-Laurent, Quebec, Canada H4R 2C9  
T (514) 225-4304 F (514) 931-4862  
[www.lumenwerx.com](http://www.lumenwerx.com)



Lumenwerx reserves the right to modify product specifications without notification.  
© Lumenwerx, ULC. All rights reserved.

VIA3-PERIMETER-SPEC-REV5 September 15, 2025



# VIA 3 PERIMETER

RECESSED  
STATIC WHITE



## Dimensions

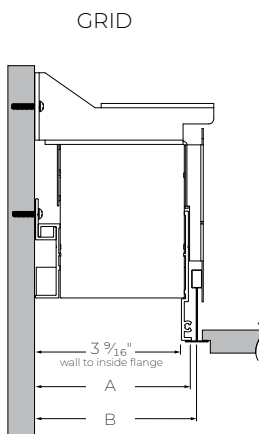
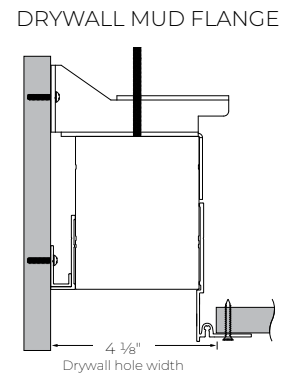
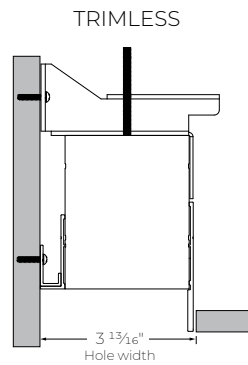
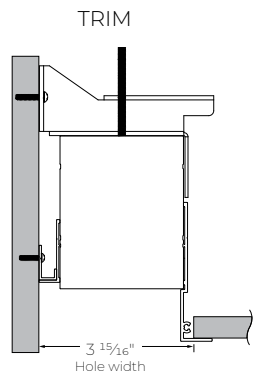
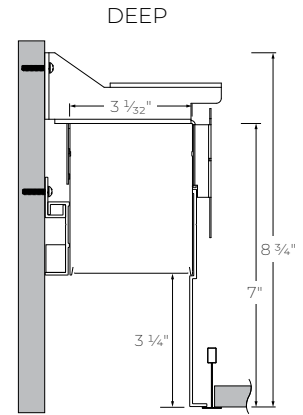
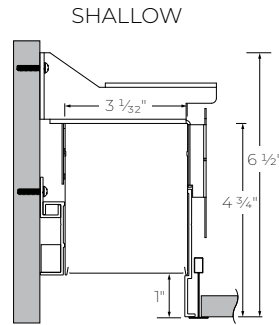
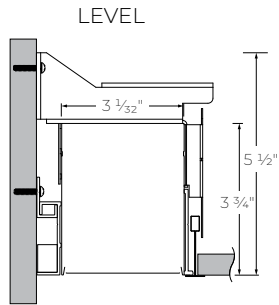

	TC9  Tegular 9/16"	TB9  T-bar 9/16"	TC15  Tegular 15/16"	TB15  T-bar 15/16"	ST  Screw slot T-bar
A wall to flange	3 13/16"		3 15/16"		3 13/16"
B wall to T-bar	3 7/8"		4"		3 7/8"

# VIA 3 PERIMETER

RECESSED  
STATIC WHITE



## Photometrics

Values calculated based on a 4' fixture at 3500K for all optics.

HLO

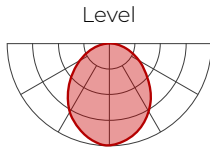

LM/FT	W/FT	LM/W
500	4.1	121
750	6.4	117
1000	8.8	114

ARFO

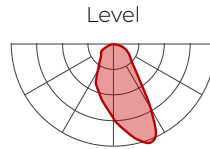

LM/FT	W/FT	LM/W
500	5.5	91
750	8.8	85
1000	12.4	81

MPO

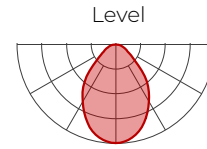

LM/FT	W/FT	LM/W
500	4.5	112
750	6.8	111
1000	9.5	105

Shallow

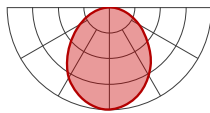

LM/FT	W/FT	LM/W
500	4.2	118
750	6.5	115
1000	9	111

Shallow

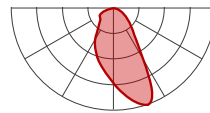

LM/FT	W/FT	LM/W
500	5.6	89
750	8.9	84
1000	12.5	80

Shallow

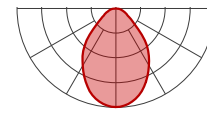

LM/FT	W/FT	LM/W
500	4.6	109
750	6.9	109
1000	9.7	103

Deep

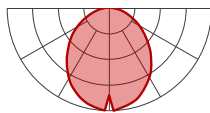

LM/FT	W/FT	LM/W
500	4.4	113
750	6.9	109
1000	9.5	105

Deep

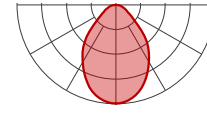

LM/FT	W/FT	LM/W
500	4.8	104
750	7.3	103
1000	10.3	98

## MULTIPLIER TABLE

Use this table to get results for different color temperatures for all photometric tables.

Multiplier - CCT/CRI

CCT	WATTS	LPW
	80+ CRI / 90+ CRI	80+ CRI / 90+ CRI
2700K	1.05	0.95
3000K	1.02	0.98
3500K	1.00	1.00
4000K	1.00	1.00
5000K	0.96	1.04

# VIA 3 PERIMETER

RECESSED  
STATIC WHITE



## End Configurations

STANDARD

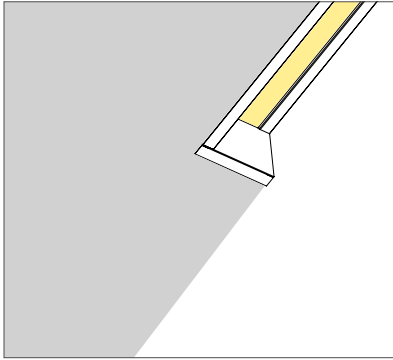

OPTIONS

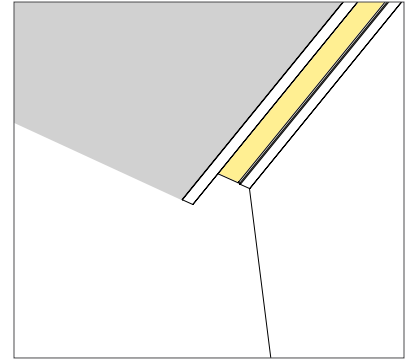
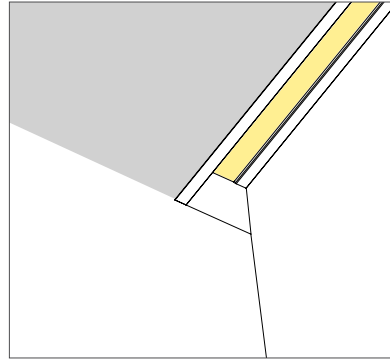

NEF - No end flanges

FEP - Flush end plates

## Adjustable End Sleeve - TES

Adjustable end sleeve (TES) is designed to provide on-site luminaire adjustability of +2.5" to -4.5". A sleeve accommodates an easy installation and maintenance. Please refer to the [End Sleeve Adjustment Installation Instructions](#) for more details.

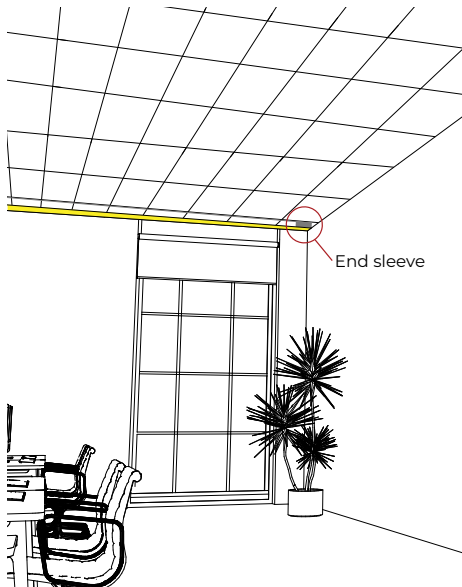

X = Fixture measure provided by client.  
X + 2.5" = Measurement built and supplied.

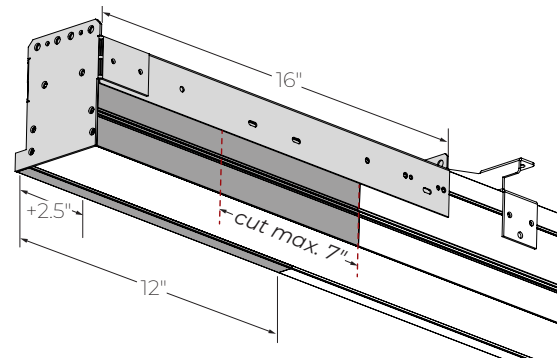
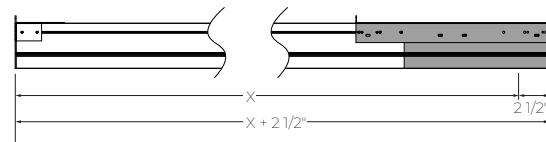

# VIA 3 PERIMETER

RECESSED

STATIC WHITE



## Technical Specifications

### OPTICS

#### High-Efficiency Lambertian Optic (HLO)

The High-Efficiency Lambertian Optic (HLO) uses matte white reflectors to distribute LED output across 0.075" acrylic shielding, providing up to 88% transmission and good obscuration. Luminaire brightness is controlled by the flux-to-shielding area ratio.

#### Asymmetric Room Fill Optic (ARFO)

Our Asymmetric Room Fill Optic employs an advanced optical system to illuminate rooms and corridors from the perimeter, providing a direct distribution of light with precision and minimal glare.

#### Micro-Prismatic Optic (MPO)

The Micro-Prismatic Optic (MPO) delivers high-efficiency, low-glare illumination with UGR <17. Its precision-engineered lens, composed of thousands of tiny prisms, diffuses light to reduce glare, producing a ceiling plane that reads smooth from a distance while revealing subtle texture up close. The result is balanced, efficient illumination with a refined architectural presence.

### LIGHT SOURCE

Custom linear array of mid-flux LEDs are cartridge-mounted with quick-connect wiring to facilitate service and thermal management. Available in 2700K, 3000K, 3500K, 4000K, and 5000K with a minimum 80+ CRI and an option for 90+ CRI with elevated R9 value. Color consistency maintained to within 3 SDCM. LEDs operated at reduced drive current to optimize efficacy and lumen maintenance. All LEDs have been tested in accordance with IESNA LM-80-08 and the results have shown L80 lumen maintenance greater than 60,000 hours. Absolute product photometry is measured and presented in accordance with IESNA LM-79, unless otherwise indicated.

### LUMINAIRE LENGTH

Via 3 Perimeter is made up of standard 2' to 12' (up to 8' for MPO) sections that may be joined together to create longer continuous run lengths. Exact run lengths must be noted in the product code. The minimum individual section available is 2'.

All individual sections are joined together onsite using the joiner kits provided. Lumenwerx offers joiner kits that are extremely simple to work with in the field and result in a fixture that appears virtually seamless with no light leak at any connection.

### ELECTRICAL

Factory-set, adjustable output current LED driver with universal (120-277 VAC) input. Dimmable from 100% to 1% with 0-10V dimming control. Rated life (90% survivorship) of 50,000 hours at 50°C max. ambient (and 70°C max. case) temperature. At maximum driver load: Efficiency>84%, PF>0.9, THD<20%. Other specifiable options include Lutron Hi-Lume 1% Eco, eldoLED 1% ECOdrive 0-10V, eldoLED 0.1% SOLOdrive 0-10V, and DALI protocol drivers. All of our standard 0-10V drivers are NEMA 410 compliant. ELV and TRIAC dimming performance (including minimum dimming percentage) subject to dimmer selection.

### PoE

Depending on the PoE manufacturer selected, Lumenwerx will install the node in factory as either integral to the luminaire or as a remote module. Factory programming of the PoE node may or may not enable the following functionalities: lumen package, DUO (tunable white), QUADRO (RGBW), emergency battery backup, and sensor integration. These must be addressed and evaluated on a case-by-case basis.

### ELECTRICAL SECTION OPTIONS

Electrical section options are available for fixtures specified as multi circuit (#MC). With MC, specify the total number of circuits (#), including any circuits required for optional electrical sections. A drawing is required to specify the layout. Please consult factory for custom configurations.

### Electrical sections

Options include emergency-powered (#EC##), night light (#NL##), daylight (#DL##), and generator transfer device (#GTD##) sections. Specify the quantity (#), as well as the section length in inches (##).

Example 1: A 32' Direct fixture with two 8' emergency-powered sections on a second circuit.

Code: 2MC-2EC96

Example 2: A 24' Direct fixture with one 4' generator transfer device section.

Code: 1MC-1GTD48

### Battery

Each emergency battery (#EMB) powers a 4' section. All batteries will be on the same circuit. Specify the number of batteries (#) required.

Factory installed long life, high temperature, maintenance-free Lithium-Ion battery pack with self-test functionality, test switch and charge indicator. Minimum of 90 minutes operation, up to 1000 lumens per 4' (25°C) emergency lighting output and recharge time of 24 hours.

# VIA 3 PERIMETER

RECESSED

STATIC WHITE



## MOUNTING

Recessed fixtures can be mounted into exposed or concealed T-bar or tegular ceiling, as well as in ceilings with trim, trimless, or mud flange options.

## FINISH

**Interior:** 95%, reflective matte powder coated white paint

**Exterior:** Matte white powder coating.

Custom finishes are also available.

## CONTROLS

Lumenwerx offers several options for integrating occupancy and daylight harvesting controls in our luminaires.

For latest information on sensors, click [here](#).



### Standalone controls

An integrated standalone sensor controls the luminaire in which it is installed. Depending on the length, more than one sensor may be necessary and may control the entire luminaire, or just a section of it. These controls operate independently. Unless otherwise agreed, location and functionality of the sensor within the luminaire are selected by Lumenwerx. See client drawings for details.

One type is available:

**ODS:** An integral, daylight harvesting sensor with closed-loop operation dims the luminaire in which it is installed in order to compensate for available daylight. The sensor measures the combination of daylight and luminaire light reflected from horizontal surfaces below the luminaire. Initial onsite calibration is required via the use of provided remote control.

### Connected controls

With connected controls, sensors or nodes installed in the luminaire form part of a larger control system infrastructure from manufacturers such as: Lutron, Encelium, Cooper Wavelinx, Acuity nLight, Casambi, Legrand, and others. These connected controls allow for a scalable system providing features like occupancy and daylight control, manual control, scheduling and configuration of various zones and scenes. Energy reporting and system monitoring are also possible. Specific capabilities depend on the control system being used.

Lumenwerx installs the components (sensors, nodes, power packs, etc) which may be supplied to us by a third party, or procured directly by Lumenwerx, depending on the control system manufacturer.

Lumenwerx is solely responsible for the installation of specified components; the controls manufacturer is responsible for performance of the control system.

To indicate a Lumenwerx luminaire with connected controls, identify the specific onsite control system to be integrated into the luminaires using the ordering code. Due to the diversity of components, you must contact factory to assure complete compatibility with intended control system and to fully specify the luminaire.

Complete control specifications, sensor/node/power pack layout, and narrative for the control system are required for Lumenwerx to create shop drawings and submittals.

## CONSTRUCTION

**Housing:** Extruded aluminum, up to 90% recycled content

**Interior brackets:** Die-formed cold rolled sheet steel

**Joining system:** Die-cast zinc

**Reflectors:** Flat rolled aluminum sheet or die-formed cold rolled steel, 95% reflective matte white painted

**Lens:** Acrylic

**Recessed flanges:** Extruded aluminum, up to 90% recycled content

**End plate:** Die-formed cold rolled sheet steel

## MAINTENANCE

LED boards are housed in a removable cartridge for easy replacement. Driver is accessible from below.

## WEIGHT

**4':** 11.12 lbs - 5.05 kg

**8':** 22.25 lbs - 10.1 kg

**12':** 33.48 lbs - 15.2 kg

## CERTIFICATIONS

**ETL:** Rated for indoor dry/damp locations. Conforms to UL Standard 1598 and certified to CAN/CSA Standard C22.2 No. 250.0.

**Chicago Plenum:** City of Chicago Approved (CCEA) when specified with CP option.

**IC rated:** Suitable for direct contact with insulation

**Declare:** [LBC Red List Approved](#)

## WARRANTY

Lumenwerx provides a five-year limited warranty on electrical and mechanical performance of the luminaires, including the LED boards, drivers, and auxiliary electronics. Lumenwerx will repair or replace defective luminaires or components at our discretion, provided they have been installed and operated in accordance with our specifications. Other limitations apply, please refer to the full warranty on our website.