

VIA 3 PERIMETER

RECESSED

CHROMAWERX - SOLA, DUO



Project: _____

Type: _____



Via 3 Perimeter Deep

DESCRIPTION

Via 3 Perimeter creates a continuously illuminated "slot" at the wall/ceiling intersection. Lighted corners with adjustable end sleeves are available. Via Perimeter installs in grid or drywall ceilings in a choice of three arrangements: level, shallow 1", and deep 3 1/4".



Declare. IC RATED

Order Guide

LUMINAIRE ID	OPTIC	LIGHT SOURCE ²	CRI	LUMEN PACKAGE	LUMINAIRE LENGTH
V3PERL - Via 3 Perimeter Level V3PERS - Via 3 Perimeter Shallow V3PERD - Via 3 Perimeter Deep	HLO - High-Efficiency Lambertian Optic ARFO ¹ - Asymmetric Room Fill Optic MPO - Micro-Prismatic Optic ¹ Not available with Deep fixtures.	SOLA - Dim-to-warm single channel control 35K to 22K DUO - Tunable white 2-channel control 65K to 27K ² Static white and Chromawerx QUADRO also available. Consult other spec sheets.	80CRI - 80+ CRI 90CRI - 90+ CRI	500LMF - Low output 500 lm/ft 750LMF - Medium output 750 lm/ft 1000LMF - High output 1000 lm/ft	#FT#IN ³ - Specify nominal length (#) in 1' and/or 1" increments Standard nominal lengths: Single units: 3' to 12' (up to 8' for MPO) Continuous runs: lengths over 12' (8' for MPO) ³ Minimum 4' for DMX.

VOLTAGE	DRIVER ⁴	ELECTRICAL	MOUNTING	FINISH	OPTIONS ⁷	ADJUSTABLE SLEEVE (optional) ¹⁰	
		1C					
120V - 120V 277V - 277V UNV - 120V-277V	<u>SOLA</u> SD1 - Single 0-10V input ⁴ PoE (Power-over-Ethernet) compatible. Consult factory for details. ⁵ For more information, see pages 7 to 12. ⁶ On-site commissioning is required.	<u>DUO</u> DMX ^{5,6} - DMX DDA ⁶ - DALI DT6 DDA8 ⁶ - DALI DT8 DD1 - Dual 0-10V input for CCT/intensity LD2 ⁶ - Lutron DALI-2 digital	1C - 1 circuit	TC9 - Tegular 9/16" TG15 - Tegular 15/16" TB9 - T-bar 9/16" TB15 - T-bar 15/16" ST - Screw slot T-bar DTR - Trim DTL - Trimless DMF - Drywall mud flange	W - Matte white CF# - Custom finish, specify RAL#	NEF ^{8,9} - No end flanges FEP ⁹ - Flush end plates FU120 - Fuse 120V FU277 - Fuse 277V FWC - Flexible whip cable (6' std) CP - Chicago Plenum NA - None ⁷ Separate codes with a "*" if more than one is specified. ⁸ For wall-to-wall installations. ⁹ See page 4 for details.	TES ¹¹ - Adjustable end sleeve NA - None ¹⁰ See page 4 for details. ¹¹ Minimum 3' length with SD1 (SOLA). Minimum 4' length with all other drivers.

Accessories

Optional, order separately

WALL CONTROLLER ¹²	
DMX	DD1
WCW##FT ¹³ - DMX wall controller white WCB##FT ¹³ - DMX wall controller black ¹² Specify wire length (##) in feet. ¹³ Available with DMX only. For more information, see pages 7 to 12, or consult factory. ¹⁴ Available with DD1 only. For more information, see page 13, or consult factory.	TWCW##FT ¹⁴ - Dual 0-10V wall controller white TWCB##FT ¹⁴ - Dual 0-10V wall controller black

TECHZONE™ & USG Compatible with 4" ceiling

3737 Cote Vertu St-Laurent, Quebec, Canada H4R 2C9
 T (514) 225-4304 F (514) 931-4862
www.lumenwerx.com



Lumenwerx reserves the right to modify product specifications without notification.
 © Lumenwerx, ULC. All rights reserved.



VIA3-PERIMETER-TW-SPEC-REV4 September 12, 2025

VIA 3 PERIMETER

RECESSED

CHROMAWERX - SOLA, DUO



Dimensions

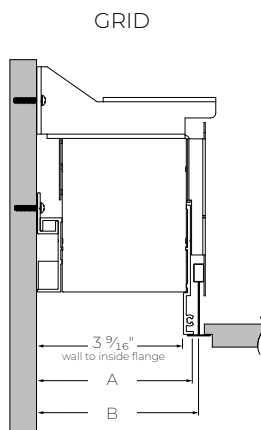
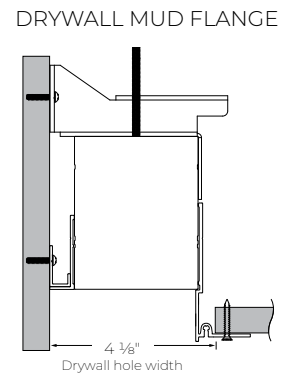
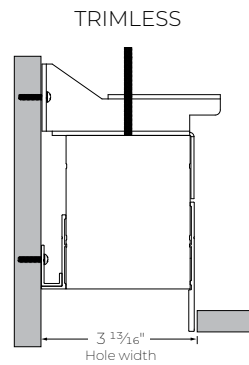
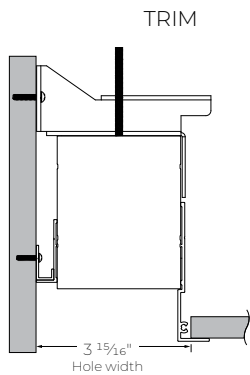
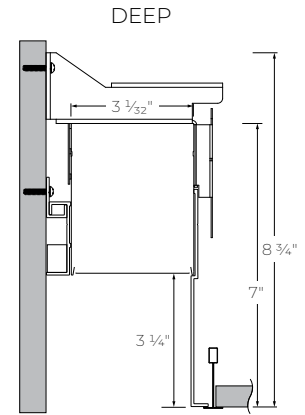
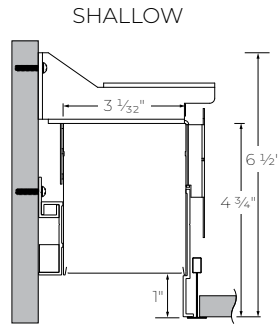
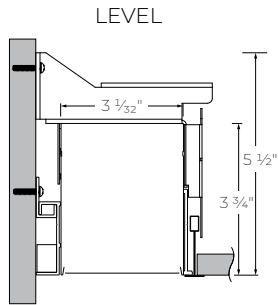

	TC9 Tegular 9/16"	TB9 T-bar 9/16"	TC15 Tegular 15/16"	TB15 T-bar 15/16"	ST Screw slot T-bar
A wall to flange	3 13/16"		3 15/16"		3 13/16"
B wall to T-bar	3 7/8"		4"		3 7/8"

VIA 3 PERIMETER

RECESSED

CHROMAWERX - SOLA, DUO



Photometrics

Values calculated based on a 4' fixture at 3500K for all optics.

HLO

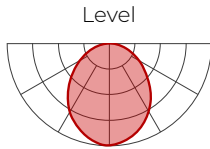

LM/FT	W/FT	LM/W
500	4.1	121
750	6.4	117
1000	8.8	114

ARFO

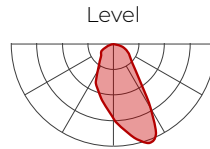

LM/FT	W/FT	LM/W
500	5.5	91
750	8.8	85
1000	12.4	81

MPO

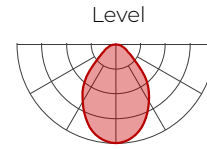

LM/FT	W/FT	LM/W
500	4.5	112
750	6.8	111
1000	9.5	105

Shallow

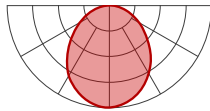

LM/FT	W/FT	LM/W
500	4.2	118
750	6.5	115
1000	9	111

Shallow

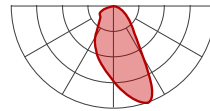

LM/FT	W/FT	LM/W
500	5.6	89
750	8.9	84
1000	12.5	80

Shallow

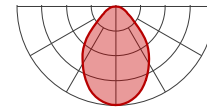

LM/FT	W/FT	LM/W
500	4.6	109
750	6.9	109
1000	9.7	103

Deep

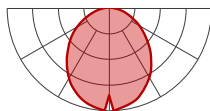

LM/FT	W/FT	LM/W
500	4.4	113
750	6.9	109
1000	9.5	105

Deep

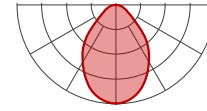

LM/FT	W/FT	LM/W
500	4.8	104
750	7.3	103
1000	10.3	98

MULTIPLIER TABLES

Use these tables to get results for different color temperatures for all photometric tables.

SOLA

CCT	WATTS	LPW
	80+ CRI / 90+ CRI	80+ CRI / 90+ CRI
3500K	1.00	1.00

DUO

CCT	WATTS	LPW
	80+ CRI / 90+ CRI	80+ CRI / 90+ CRI
2700K	1.05	0.95
6500K	1.00	1.00

VIA 3 PERIMETER

RECESSED

CHROMAWERX - SOLA, DUO



End Configurations

STANDARD

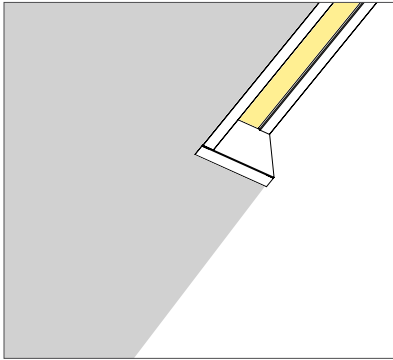

OPTIONS

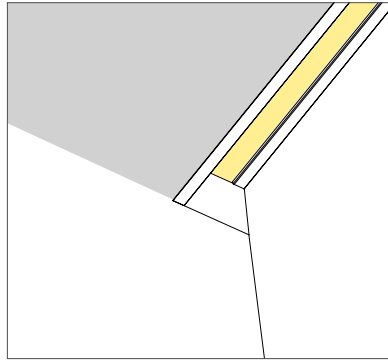

NEF - No end flanges

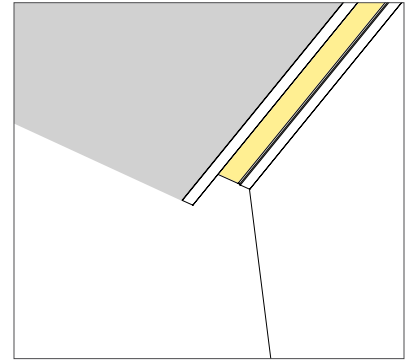

FEP - Flush end plates

Adjustable End Sleeve - TES

Adjustable end sleeve (TES) is designed to provide on-site luminaire adjustability of +2.5" to -4.5". A sleeve accommodates an easy installation and maintenance. Please refer to the [End Sleeve Adjustment Installation Instructions](#) for more details.

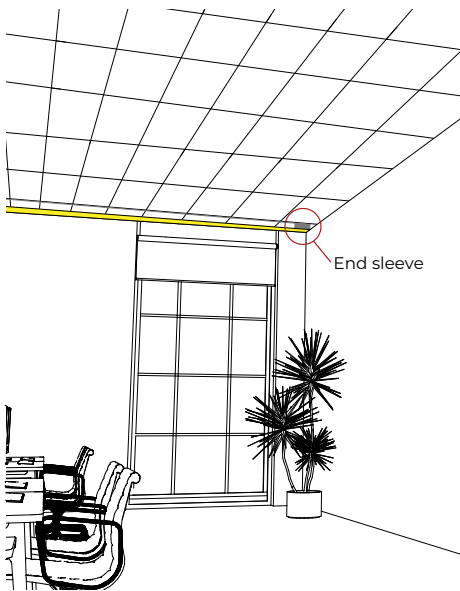

X = Fixture measure provided by client.
X + 2.5" = Measurement built and supplied.

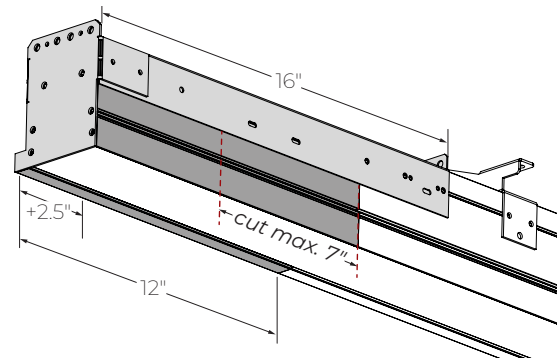
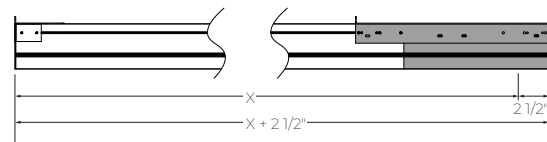

VIA 3 PERIMETER

RECESSED

CHROMAWERX - SOLA, DUO



Technical Specifications

OPTICS

High-Efficiency Lambertian Optic (HLO)

The High-Efficiency Lambertian Optic (HLO) uses matte white reflectors to distribute LED output across 0.075" acrylic shielding, providing up to 88% transmission and good obscuration. Luminaire brightness is controlled by the flux-to-shielding area ratio.

Asymmetric Room Fill Optic (ARFO)

Our Asymmetric Room Fill Optic employs an advanced optical system to illuminate rooms and corridors from the perimeter, providing a direct distribution of light with precision and minimal glare.

Micro-Prismatic Optic (MPO)

The Micro-Prismatic Optic (MPO) delivers high-efficiency, low-glare illumination with UGR <17. Its precision-engineered lens, composed of thousands of tiny prisms, diffuses light to reduce glare, producing a ceiling plane that reads smooth from a distance while revealing subtle texture up close. The result is balanced, efficient illumination with a refined architectural presence.

LIGHT SOURCE

Custom linear array of alternating color temperature mid-flux LEDs are mounted directly to the housing for optimal thermal performance. For the DUO products, a color temperature range from 6500K-2700K is achievable with color points on or below the black body curve. For the SOLA products, a color temperature range from 3500K-2200K is controlled synchronously with intensity. Color consistency between fixtures is maintained to within 3 SDCM. LEDs operate at reduced drive current to optimize efficacy and lumen maintenance. All LEDs have been tested in accordance with IESNA LM-80-08 and the results have shown L80 lumen maintenance greater than 60,000 hours. Absolute product photometry is measured and presented in accordance with IESNA LM-79, unless otherwise indicated.

Chromawerx SOLA

It is a single-channel control that dims output while warming the color temperature in a pre-determined relationship. A simple analog control sends a common signal to dual output digital drivers, which are programmed to adjust a specially populated LED array to emulate the effect of dimming a filament source. Dimming range is programmable but the default option runs from 3500K at 100% of full power to 2200K at 5% of full power. CRI is maintained above 80 throughout the dimming range.

Chromawerx DUO

It is a two-channel control. It uses an analog (0-10V) protocol for separate control of luminaire CCT and intensity or a digital (DMX, DALI and LD2) protocol for synchronous control of both warm and cool LED arrays to enable the user to set color temperature and light output. Commonly called "tunable white", Chromawerx two-channel control provides the range of cool (6500K) to warm (2700K) color that can be useful for helping to entrain circadian rhythms, stimulate alertness for improved educational and work productivity, and compensate for jet lag, among other applications. The Chromawerx drivers are programmed to limit maximum light output and power usage across all color temperatures. CRI is maintained above 80. When paired with DALI drivers (DDA/DDA8), color tuning follows a linear dimming curve.

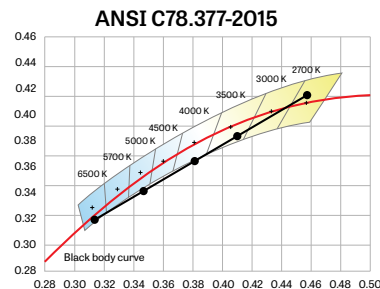

LUMINAIRE LENGTH

Via 3 Perimeter is made up of standard 3' to 12' sections (up to 8' for MPO) that may be joined together to create longer continuous run lengths. Exact run lengths must be noted in the product code. The minimum individual section available is 3'.

All individual sections are joined together onsite using the joiner kits provided. Lumenwerx offers joiner kits that are extremely simple to work with in the field and result in a fixture that appears virtually seamless with no light leak at any connection.

ELECTRICAL

SOLA

SDI

Factory-set, adjustable output current LED driver with universal (120-277 VAC) input. Using a single 0-10V control signal, the light output warms in color temperature as it dims down to 1% and 2200K. At maximum driver load, efficiency <86%, PF >0.9, THD <20%.

VIA 3 PERIMETER

RECESSED

CHROMAWERX - SOLA, DUO



DUO

DMX

Factory-set adjustable output current electronic driver with 120-277 VAC line input. Using DMX wall controls (optionally supplied by Lumenwerx) or an existing DMX control system, both channels of LEDs are independently adjustable. Each DMX driver can be independently addressed using the built-in RDM (Remote Device Management) in the field. Dimming down to 1% is attainable. Rated life (90% survivorship) of 50,000 hours at 50°C maximum ambient temperature. At maximum driver load, efficiency <84%, PF >0.9, THD <20%.

DALI

Factory-set adjustable output current electronic driver with 120-277 VAC line input. Using an existing DALI control system (supplied by others), one control channel adjusts the fixture color temperature, and the other control channel adjusts fixture brightness. With DALI Type 6, two DALI addresses are required to control both channels. With DALI Type 8, one DALI address is required to control both channels. Dimming down to 1% is attainable. Rated life (90% survivorship) of 50,000 hours at 50°C maximum ambient temperature. At maximum driver load, efficiency <84%, PF >0.9, THD <20%.

DD1

Factory-set adjustable output current LED driver with universal (120-277 VAC) input. Controlled via two individual 0-10V signals, one for setting light output down to a minimum of 1% and the other for adjusting the CCT (default range of 6500K-2700K). Rated life of 50,000 hours at 70°C maximum driver case temperature and 100% load conditions. Typical efficiency of 86%, PF >0.9, THD <20% at 100% load conditions.

LD2

Lutron DALI-2 digital drivers provide a high-performance tunable white solution with single-address digital control. Guaranteed performance and compatibility when used with Lutron DALI-2 controls.

PoE

Depending on the PoE manufacturer selected, Lumenwerx will install the node in factory as either integral to the luminaire or as a remote module. Factory programming of the PoE node may or may not enable the following functionalities: lumen package, DUO (tunable white), QUADRO (RGBW), emergency battery backup, and sensor integration. These must be addressed and evaluated on a case-by-case basis.

MOUNTING

Recessed fixtures can be mounted into exposed or concealed T-bar or tegular ceiling, as well as in ceilings with trim, trimless, or mud flange options.

FINISH

Interior: 95%, reflective matte powder coated white paint

Exterior: Matte white powder coating.

Custom finishes are also available.

CONSTRUCTION

Housing: Extruded aluminum, up to 90% recycled content

Interior brackets: Die-formed cold rolled sheet steel

Joining system: Die-cast zinc

Reflectors: Flat rolled aluminum sheet or die-formed cold rolled steel, 95% reflective matte white painted

Lens: Acrylic

Recessed flanges: Extruded aluminum, up to 90% recycled content

End plate: Die-formed cold rolled sheet steel

MAINTENANCE

LED boards are housed in a removable cartridge for easy replacement. Driver is accessible from below.

WEIGHT

4': 11.12 lbs - 5.05 kg

8': 22.25 lbs - 10.1 kg

12': 33.48 lbs - 15.2 kg

CERTIFICATIONS

ETL: Rated for indoor dry/damp locations. Conforms to UL Standard 1598 and certified to CAN/CSA Standard C22.2 No. 250.0.

Chicago Plenum: City of Chicago Approved (CCEA) when specified with CP option.

IC rated: Suitable for direct contact with insulation

Declare: [LBC Red List Approved](#)

WARRANTY

Lumenwerx provides a five-year limited warranty on electrical and mechanical performance of the luminaires, including the LED boards, drivers, and auxiliary electronics. Lumenwerx will repair or replace defective luminaires or components at our discretion, provided they have been installed and operated in accordance with our specifications. Other limitations apply, please refer to the full warranty on our website.

Wall controllers are covered by the manufacturer warranty.

VIA 3 PERIMETER

RECESSED

CHROMAWERX - SOLA, DUO



DUO DMX SPECIFICATION

A qualified DMX integrator is required to assure proper installation and commissioning of the DMX network. **When placing the PO, please provide the contact information of your DMX integrator.**

Please answer the following questions to help us identify your DMX network requirements.

YES

Do you require a wall controller provided by Lumenwerx?

NO

DMX control system supplied by others. Lumenwerx will supply DMX-enabled fixtures with default DMX addressing. See following pages for technical DMX informations. ✓

DMX controller supplied by Lumenwerx

How many zones do you have?

A zone consists of one or more luminaires behaving identically.

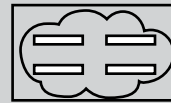

1 Zone



2 Zones

How to calculate the required number of drivers:

per 4' fixture

Driver

1x driver

Direct only

per 4' fixture

Driver

Driver

2x driver

Direct high output

To Calculate # of drivers

NO

YES

1 - 4 Zones

5 or more Zones

Do you have more than 32 drivers in total?

Order a standard Lumenwerx wall controller.

WALL CONTROLLER

WCW - wall controller white

WCB - wall controller black

Add the control code at the end of your order code.

Please provide a fixture layout or RCP (Reflected Ceiling Plan) showing the locations of the DMX fixtures, zones and the DMX wall controller.

Refer to your DMX integrator for the installation. ✓

Subject to factory evaluation. Please contact our controls specialist at controls@lumenwerx.com. Additional cost and equipment will be required. ✓

Subject to factory evaluation and approval. Please contact our controls specialist at controls@lumenwerx.com. Additional cost and equipment will be required. ✓

VIA 3 PERIMETER

RECESSED

CHROMAWERX - SOLA, DUO



GENERIC DMX NETWORK ARCHITECTURE

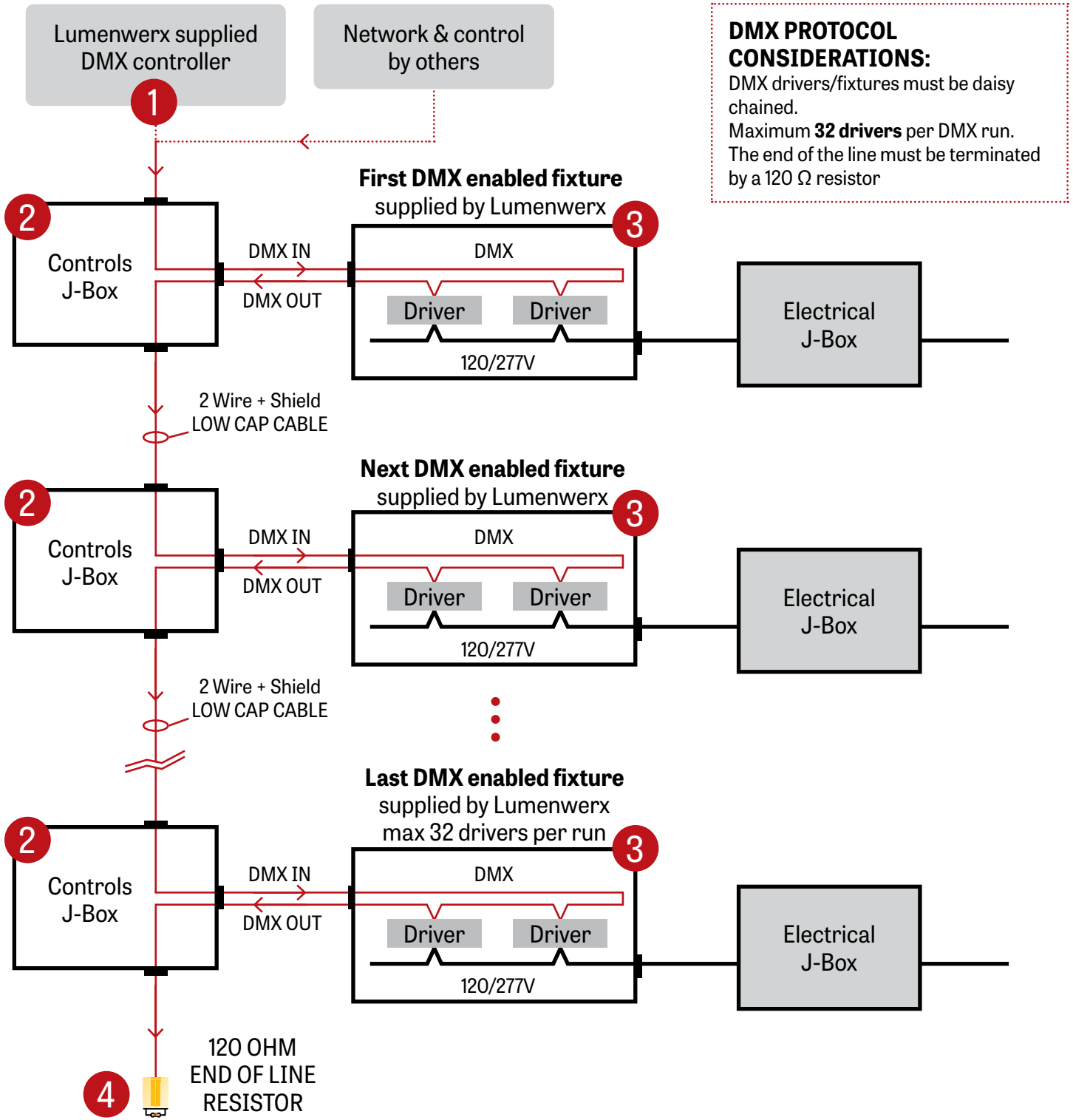

DMX PROTOCOL CONSIDERATIONS:
 DMX drivers/fixtures must be daisy chained.
 Maximum **32 drivers** per DMX run.
 The end of the line must be terminated by a 120 Ω resistor

VIA 3 PERIMETER

RECESSED

CHROMAWERX - SOLA, DUO



1 LUMENWERX SUPPLIED DMX CONTROLLER

To the first fixture

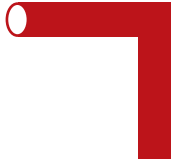

2 Wire +
Shield Low Cap Cable

WALL BOX SUPPLIED BY OTHERS

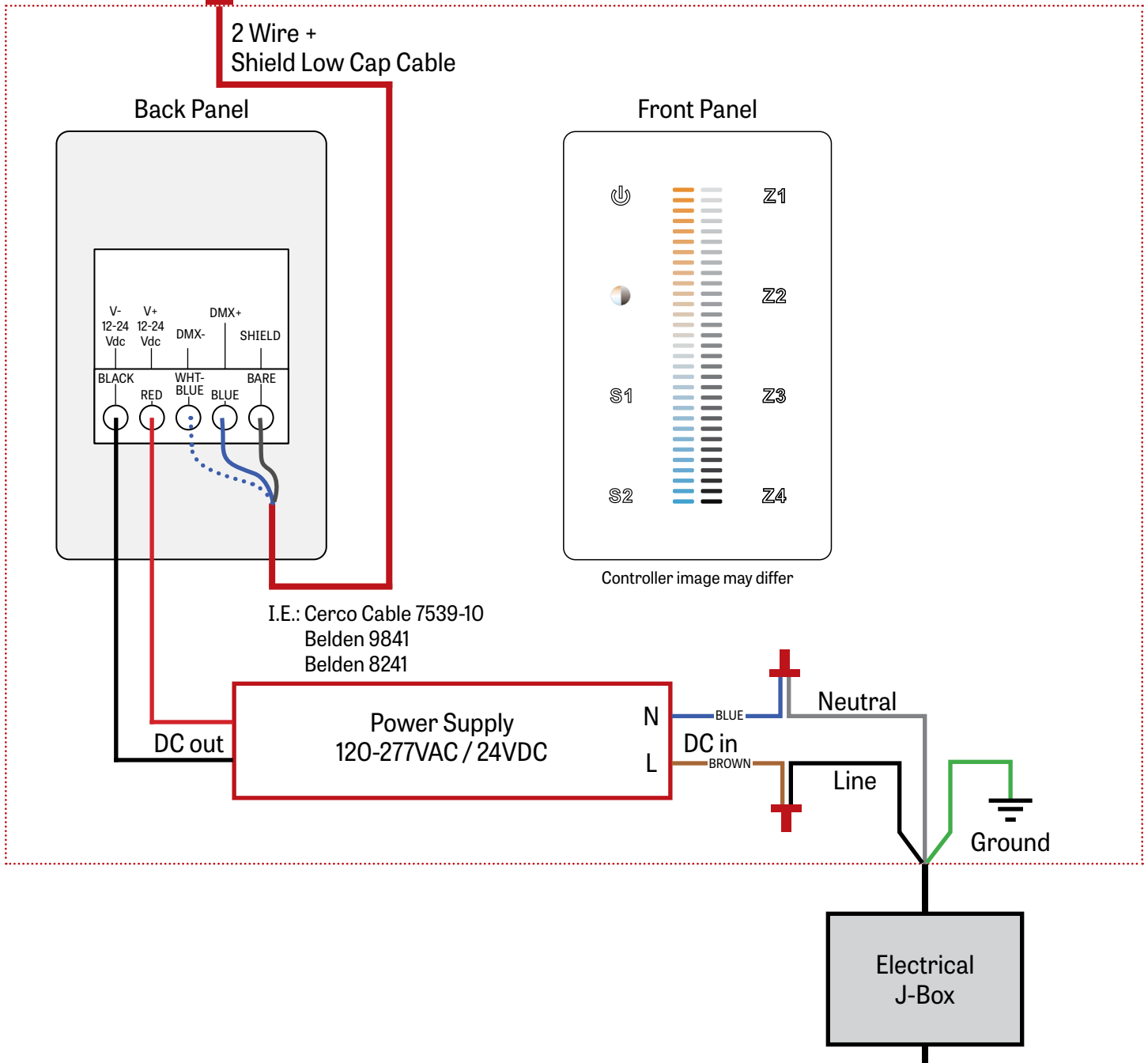

VIA 3 PERIMETER

RECESSED

CHROMAWERX - SOLA, DUO



4 DMX LAST FIXTURE DETAIL

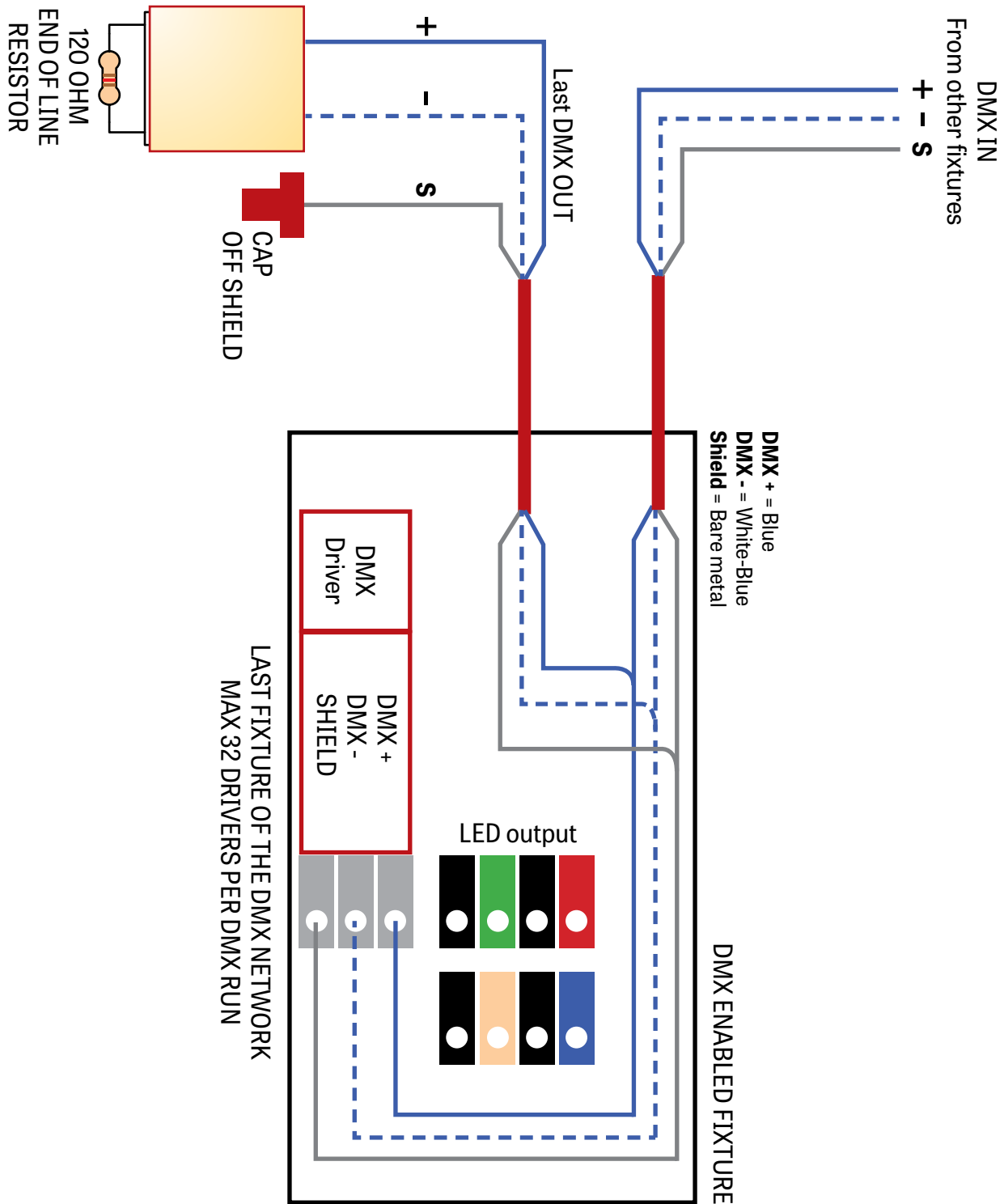

VIA 3 PERIMETER

RECESSED

CHROMAWERX - SOLA, DUO



DMX WALL CONTROLLER

DUO 1-4 ZONE

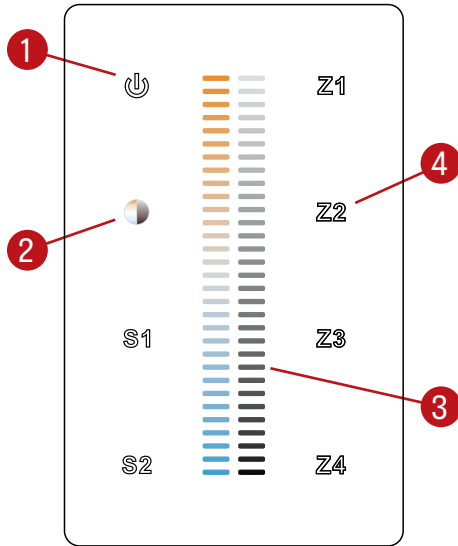

- (1) Power: Use this button to turn ON or OFF the fixture.
- (2) Brightness/CCT: Use the color/brightness toggle button to choose between color/brightness. When Blue: brightness is selected, when Yellow: color is selected.
- (3) Slider: Depending on the mode chosen in step 2, the slider will allow the user to set desired color or brightness.
- (4) Zone select: Up to 4 zones can be selected either independently or together. Once selected, the commands will be sent to the zone identified by a Blue LED.

Default DMX Addresses:

- 1 Warm
- 2 Cool

VIA 3 PERIMETER

RECESSED

CHROMAWERX - SOLA, DUO



DUAL 0-10V WALL CONTROLLER

Front Panel

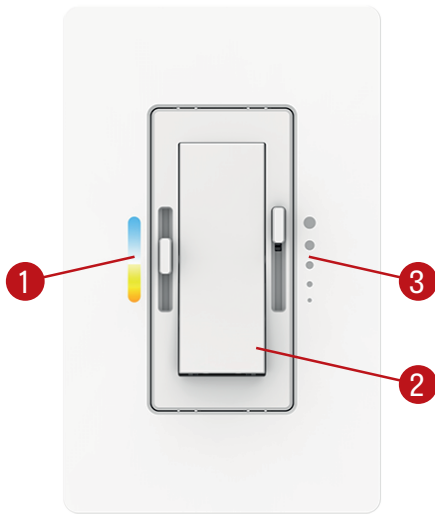

Controller image may differ

Dimensions

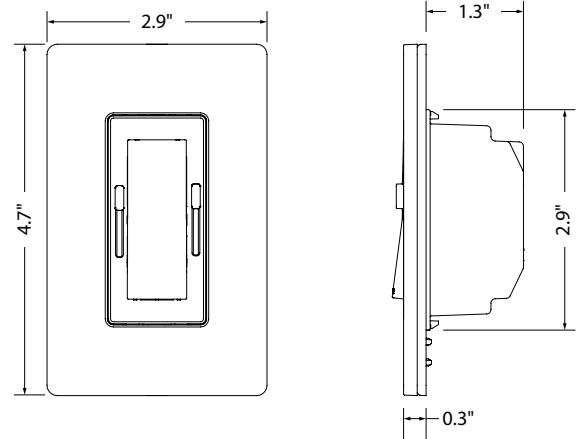

- (1) CCT control: Use this button to adjust the color temperature.
- (2) On/Off switch: Use this button to turn ON or OFF the fixture.
- (3) Dimming control: Use this button to adjust the brightness.

Wiring Diagram

