

# VIA 4 RECESSED

DIRECT  
STATIC WHITE, BIOS



IC RATED Declare.



**SENSORS**  
For latest information on sensors, click [here](#).

### Lens Positions

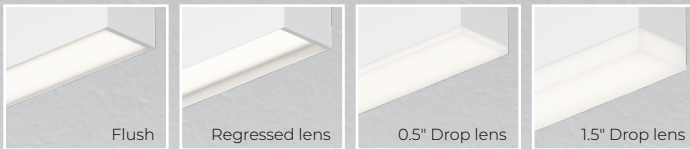

### Module Options

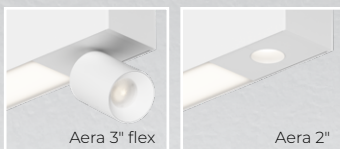

Our elegant, flexible Via family is composed of linear, pendant, surface, recessed, and wall mounted luminaires. Each lighting fixture can be installed as a discrete luminaire or in continuous runs or patterns. Via 4 Recessed is offered with Lambertian, asymmetric, widespread, wall wash, or low-glare optics.

### DIRECT



# VIA 4 RECESSED



DIRECT  
STATIC WHITE, BIOS

Project: \_\_\_\_\_  
 \_\_\_\_\_  
 Type: \_\_\_\_\_  
 \_\_\_\_\_

## Order Guide

LUMINAIRE ID	DISTRIBUTION	OPTIC	LENS POSITION	LIGHT SOURCE <sup>2</sup>
<b>VIA4R</b>	<b>D</b>			
<b>VIA4R</b> - Via 4" Recessed	<b>D</b> - Direct	<b>HLO</b> - High-Efficiency Lambertian Optic <b>ARO2</b> - Asymmetric Refractive Optic <b>WRO2</b> - Wall Wash Refractive Optic <b>WDO</b> - Widespread Direct Optic <b>LGO</b> - Low-Glare Optic <b>MPO</b> - Micro-Prismatic Optic	<b>FH</b> <sup>1</sup> - Flush <b>RG</b> <sup>1</sup> - Regressed <b>0.5D</b> <sup>1</sup> - 0.5" drop <b>1.5D</b> <sup>1</sup> - 1.5" drop  <sup>1</sup> For HLO, specify FH, RG, 0.5D, or 1.5D. <sup>1</sup> For ARO2, WRO2, WDO, LGO, and MPO, specify FH.	<b>SW</b> - Static white  <b>BIOSST</b> <sup>3,4</sup> - BIOS Biological Static <b>BIOSDY</b> <sup>3,4</sup> - BIOS Biological Dynamic <b>BIOSTU</b> <sup>3,4</sup> - BIOS Biological Tunable

CRI	LUMEN PACKAGE	COLOR TEMP.	LUMINAIRE LENGTH	VOLTAGE
<b>80CRI</b> - 80+ CRI <b>90CRI</b> <sup>5</sup> - 90+ CRI  <sup>5</sup> Not available with BIOS.	<b>350LMF</b> <sup>6</sup> - Hypo output 350 lm/ft <b>500LMF</b> - Low output 500 lm/ft <b>750LMF</b> - Medium output 750 lm/ft <b>1000LMF</b> - High output 1000 lm/ft <b>1200LMF</b> - Ultra high output 1200 lm/ft <b>1500LMF</b> <sup>7,8</sup> - Hyper output 1500 lm/ft  <sup>6</sup> Minimum 3' fixture. <sup>7</sup> Available with HLO only. <sup>8</sup> Fixture will be very bright. Use in suitable applications.	<b>27K</b> <sup>9</sup> - 2700K <b>30K</b> - 3000K <b>35K</b> - 3500K <b>40K</b> - 4000K <b>50K</b> <sup>9</sup> - 5000K  <sup>9</sup> Not available with BIOS.	<b>#FT#IN</b> - Specify nominal length (#) in 1' and/or 1" increments  <b>Standard nominal lengths:</b> Single units: 2' to 12' (up to 8' for MPO) Continuous runs: lengths over 12' (8' for MPO)	<b>120V</b> - 120V <b>277V</b> - 277V <b>UNV</b> - 120V-277V <b>347V</b> <sup>10</sup> - 347V  <sup>10</sup> Available with D1 driver only.

DRIVER <sup>11</sup>	ELECTRICAL	ELECTRICAL SECTIONS (optional) <sup>17,18</sup>	MOUNTING <sup>23</sup>
<b>D1</b> - 1% 0-10V <b>DA</b> <sup>12</sup> - DALI <b>LDEI</b> <sup>12</sup> - Lutron Hi-lume 1% Eco <b>ELD1</b> - eldoLED 1% ECOdrive 0-10V <b>ELDO</b> - eldoLED 0.1% SOLOdrive 0-10V <b>ELV</b> <sup>13</sup> - ELV 120V <b>TRI</b> <sup>13</sup> - TRIAC 120V  <sup>11</sup> PoE (Power-over-Ethernet) compatible. Consult factory for details. <sup>12</sup> On-site commissioning is required. <sup>13</sup> Available with 120V only.	<b>1C</b> - 1 circuit <b>#MC</b> <sup>14</sup> - Multi circuit <b>EC</b> - Emergency-powered fixture <b>NL</b> - Night light fixture <b>DL</b> - Daylight fixture <b>GTD</b> <sup>15,16</sup> - Generator transfer device fixture  <sup>14</sup> Specify total number of circuits (#), including any required for electrical section or module options. Provide drawing or layout specifications. Minimum 4' section per circuit. <sup>15</sup> Minimum 4' fixture. <sup>16</sup> Not available with 347V.	<b>#EC##</b> <sup>19</sup> - Emergency-powered section <b>#NL##</b> <sup>19</sup> - Night light section <b>#DL##</b> <sup>19</sup> - Daylight section <b>#GTD##</b> <sup>19,20,21</sup> - Generator transfer device section <b>#EMB</b> <sup>21,22</sup> - Emergency battery <b>NA</b> - None  <sup>17</sup> Specify with multi circuit (#MC) electrical option only. <sup>18</sup> Provide drawing or layout specifications. Consult factory for other configurations. Default section length is 4'. <sup>19</sup> Specify quantity (#), and section length in inches (##). <sup>20</sup> Minimum 4' section. <sup>21</sup> Not available with 347V. <sup>22</sup> Specify quantity (#). All batteries will be on the same circuit. Each battery powers a 4' section.	<b>TC9</b> - Tegular 9/16" <b>TG15</b> - Tegular 15/16" <b>TB9</b> - T-bar 9/16" <b>TB15</b> - T-bar 15/16" <b>ST</b> - Screw slot T-bar <b>DTR</b> - Trim <b>DTL</b> - Trimless <b>DMF</b> - Drywall mud flange  <b>MFM</b> <sup>24</sup> - Multiple flange mounting  <sup>23</sup> Transition mounting options also available (e.g. Recessed to Pendant/Surface), consult factory for details. <sup>24</sup> See page 5 for details.

FINISH	CONTROL <sup>25,26</sup>	OPTIONS <sup>32</sup>	MODULE (optional) <sup>33</sup>
<b>W</b> - Matte white <b>B</b> - Matte black <b>CF#</b> - Custom finish, specify RAL#	<b>STANDALONE CONTROLS</b> <sup>27,28</sup> Specify the quantity (#) of sensors per fixture. <b>#OMS</b> <sup>29</sup> - Onboard Occupancy <b>#OMS##</b> <sup>30</sup> - Onboard Occupancy with bi-level dimming <b>#ODS</b> - Onboard Daylight <b>#OCS</b> - Onboard Occupancy & Daylight  <b>CONNECTED CONTROLS</b> <sup>31</sup> <b>LU</b> - Lutron <b>AWNR</b> - Lutron Athena Wireless Node RF Only <b>AWNS</b> - Lutron Athena Wireless Node Sensor <b>ENC</b> - Encelium <b>WL</b> - Cooper Wavelinx <b>AN</b> - Acuity nLight <b>CA</b> - Casambi <b>LG</b> - Legrand  <b>NA</b> - None  <sup>25</sup> Standalone and connected control options cannot be combined. <sup>26</sup> Available with flush lens option only. <sup>27</sup> Available with D1 driver and 1 circuit options only. <sup>28</sup> Minimum 4' per zone. Provide control zone length.  <sup>29</sup> Fixture turns off when no occupancy. <sup>30</sup> Fixture dims to specified light level % (##). <sup>31</sup> Consult factory for connected controls.	<b>FU120</b> - Fuse 120V <b>FU277</b> - Fuse 277V <b>FWC</b> - Flexible whip cable (6' std) <b>CP</b> - Chicago Plenum <b>NA</b> - None  <sup>32</sup> Separate codes with a "+" if more than one is specified.	<b>#AE3FCY()</b> - Aera 3" Flex Cylinder <b>#AE2R()</b> - Aera 2" Round Downlight <b>NA</b> - None  <sup>33</sup> See page 3 for ordering details. • Only available with static white. • Only available with flush lens. • Not available with EMB. • Consult factory for compatibility with controls.



# VIA 4 RECESSED



DIRECT  
STATIC WHITE, BIOS

## Module Code

- For a module, specify the options in the parentheses.
- The light source is static white.
- CRI of module matches specification of main fixture.
- Minimum 4' fixture and minimum 2' section per module. Consult factory for other configurations.

Example: 1AE3FXCY(4.5IN-FTMB-BVL-FTMB-SDL-15DEG-27K-NA-10W)

MODULE <sup>1,2</sup>	HEIGHT	CYLINDER FINISH	BAFFLE	BAFFLE FINISH	LENS AT BAFFLE	BEAM ANGLE	COLOR TEMP.	ACCESSORIES AT LIGHT ELEMENT <sup>4,5</sup>	WATTAGE
<b>#AE3FXCY()</b> - Aera 3" Flex Cylinder  <sup>1</sup> Specify quantity (#). <sup>2</sup> 6" blank per module. Blank finish will match fixture finish.	<b>4.5IN</b> - 4.5"	<b>FTMB</b> - Matte black <b>FTMW</b> - Matte white <b>FCHP</b> - Champagne <b>FDBZ</b> - Dark bronze <b>CF#</b> - Custom finish, specify RAL #	<b>BVL</b> - Bevel <b>PHL</b> - Pinhole <b>BVLD</b> - Decorative bevel	<b>FTMB</b> - Matte black <b>FTMW</b> - Matte white <b>FSSPC</b> - Satin silver <b>FSSPC</b> - Matte silver <b>FCHP</b> - Champagne <b>FDBZ</b> - Dark bronze <b>CF#</b> - Custom finish, specify RAL #	<b>SDL</b> <sup>3</sup> - Soft diffused lens, Solite <b>FDL</b> <sup>3</sup> - Frosted diffused lens <b>CL</b> <sup>3</sup> - Clear lens <b>NOL</b> - No lens  <sup>3</sup> Not available with LSDL/LFDL accessories.	<b>15DEG</b> - 15° Narrow spot <b>25DEG</b> - 25° Spot <b>35DEG</b> - 35° Narrow flood <b>50DEG</b> - 50° Wide flood	<b>27K</b> - 2700K <b>30K</b> - 3000K <b>35K</b> - 3500K <b>40K</b> - 4000K <b>50K</b> - 5000K	<b>LSDL</b> - Soft diffused lens, Solite <b>LFDL</b> - Frosted diffused lens <b>LS</b> - Linear spread <b>HEX</b> - Hex louver <b>NA</b> - None  <sup>4</sup> Choose up to 2 options. Separate codes with a "+" if more than one is specified, e.g. LSDL+LS. <sup>5</sup> LSDL and LFDL cannot be combined. LS and HEX cannot be combined.	<b>10W</b> - 10 W output, up to 1132 lm <b>14W</b> - 14 W output, up to 1545 lm

Example: 1AE2R(7W-10DEG-27K-SDL-FTMB)

MODULE <sup>1,2,3</sup>	WATTAGE	BEAM ANGLE	COLOR TEMP.	LENS AT BAFFLE	BAFFLE FINISH
<b>#AE2R()</b> - Aera 2" Round Downlight  <sup>1</sup> Specify quantity (#). <sup>2</sup> 6" blank per module. Blank finish will match fixture finish. <sup>3</sup> Module is trimless.	<b>7W</b> - 7 W output, up to 714 lm <b>10W</b> - 10 W output, up to 961 lm	<b>10DEG</b> - 10° very narrow spot <b>15DEG</b> - 15° Narrow spot <b>25DEG</b> - 25° Spot <b>35DEG</b> - 35° Narrow flood <b>50DEG</b> - 50° Wide flood	<b>27K</b> - 2700K <b>30K</b> - 3000K <b>35K</b> - 3500K <b>40K</b> - 4000K <b>50K</b> - 5000K	<b>SDL</b> - Soft diffused lens, solite <b>FDL</b> - Frosted diffused lens <b>CL</b> - Clear lens	<b>FTMB</b> - Matte black <b>FTMW</b> - Matte white <b>FSSPC</b> - Satin silver <b>FSSPC</b> - Matte silver <b>FCHP</b> - Champagne <b>FDBZ</b> - Dark bronze <b>CF#</b> - Custom finish, specify RAL#

# VIA 4 RECESSED



DIRECT  
STATIC WHITE, BIOS

## Dimensions

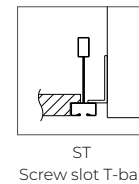
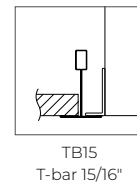
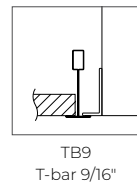
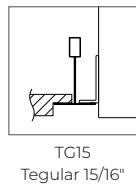
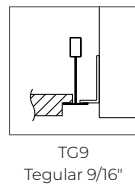
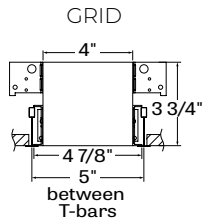
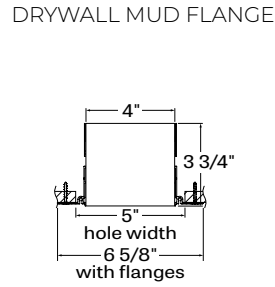
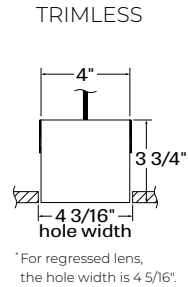
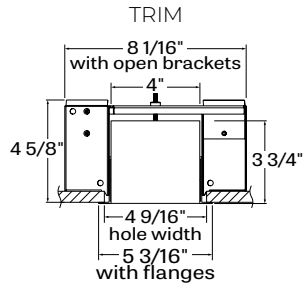

## LENS POSITIONS

Regressed Lens <sup>1</sup>

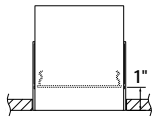

0.5" Drop Lens <sup>1</sup>

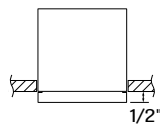

1.5" Drop Lens <sup>1</sup>

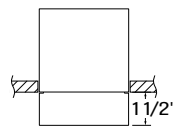

<sup>1</sup>Only available with HLO.

# VIA 4 RECESSED



DIRECT  
STATIC WHITE, BIOS

## Multiple Flange Mounting Details

Multiple flange mounting can be specified when a fixture run needs to have a multiple flange recessed mounting detail. A drawing is required to clearly illustrate the application.

CEILING CONDITION EXAMPLES (consult factory for project specific ceiling conditions)

**DRYWALL/GRID**

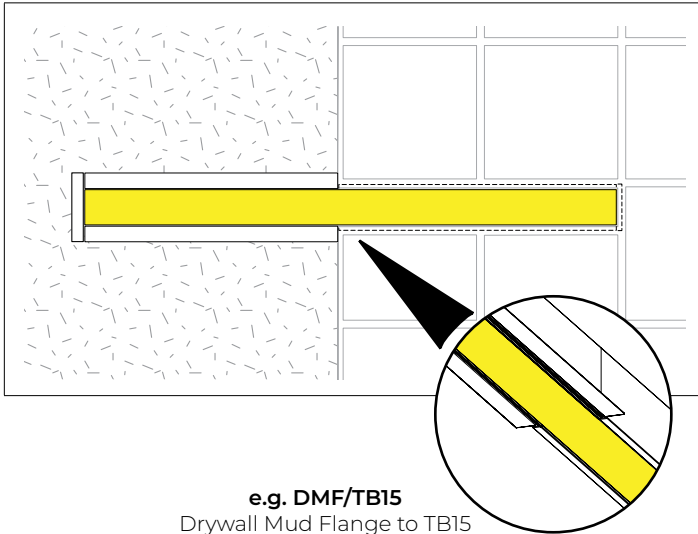

**e.g. DMF/TB15**  
Drywall Mud Flange to TB15

**DRYWALL/WOOD**

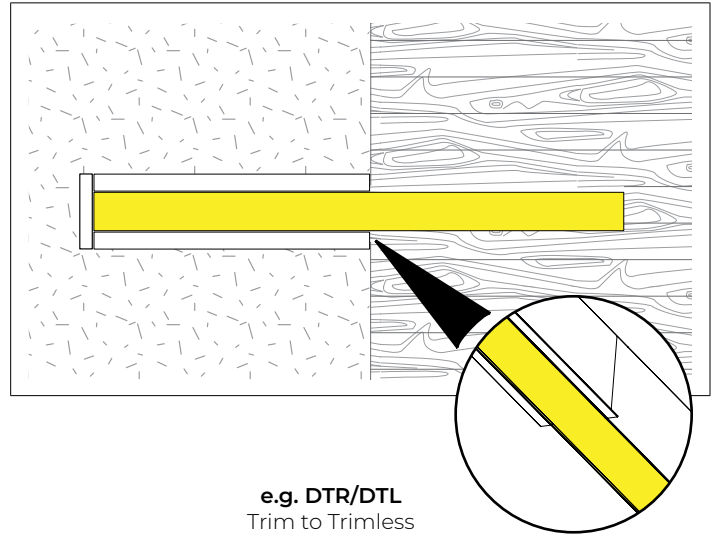

**e.g. DTR/DTL**  
Trim to Trimless

**DRYWALL/GRID**

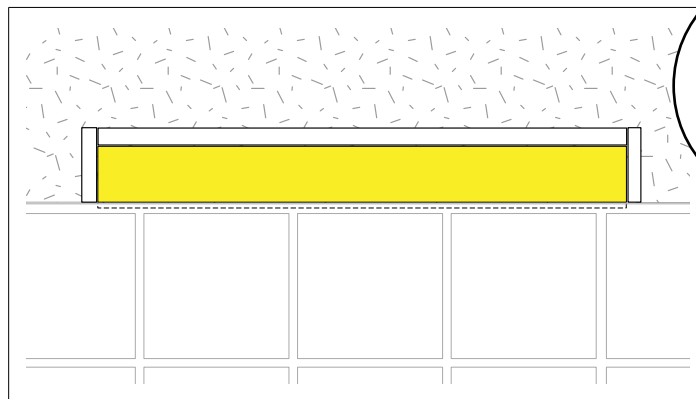

**e.g. 1TG9/3DTR**  
1 long side TG9 and other  
3 sides DTR

All drawings are for illustrative purposes only.

## TRANSITION MOUNTING OPTIONS (consult factory for details)

Mounting condition alters along the run of the fixture.

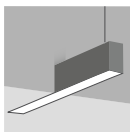

Recessed to Pendant

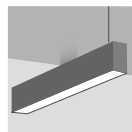

Surface to Pendant

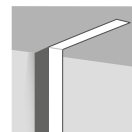

Surface to Recessed in corner

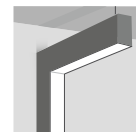

Surface to Pendant in corner

# VIA 4 RECESSED



DIRECT  
STATIC WHITE, BIOS

## Photometrics

Values calculated based on a 4' fixture at 3500K for all optics.

HLO (Flush lens)

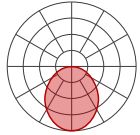

LM/FT	W/FT	LM/W
350	2.8	124
500	4.1	122
750	6.3	118
1000	8.7	115
1200	10.7	112
1500	13.8	108

ARO2

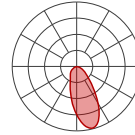

LM/FT	W/FT	LM/W
350	3.0	116
500	4.4	113
750	7.0	107
1000	9.7	103
1200	12.1	99

WRO2

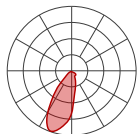

LM/FT	W/FT	LM/W
350	3.0	116
500	4.4	112
750	7.0	107
1000	9.8	102
1200	12.1	99

WDO

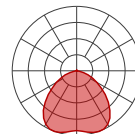

LM/FT	W/FT	LM/W
350	3.0	117
500	4.3	115
750	6.7	112
1000	9.3	108
1200	11.4	105

LGO

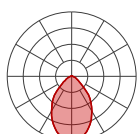

LM/FT	W/FT	LM/W
350	3.4	103
500	4.9	101
750	7.7	98
1000	10.5	95
1200	13.0	92

MPO

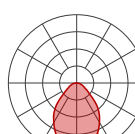

LM/FT	W/FT	LM/W
350	3.0	117
500	4.3	117
750	6.5	116
1000	8.8	113
1200	10.8	111

## MULTIPLIER TABLES

Use these tables to get results for different color temperatures and lens positions for all photometric tables.

Multiplier - CCT/CRI

CCT	WATTS		LPW
	80+ CRI / 90+ CRI	80+ CRI / 90+ CRI	
2700K	1.05	0.95	
3000K	1.02	0.98	
3500K	1.00	1.00	
4000K	1.00	1.00	
5000K	0.96	1.04	

Multiplier - Lens position

DIRECT LENS	WATTS	LPW
Flush lens	1.00	1.00
Regressed lens	0.98	1.02
Drop lens 0.5"	0.98	1.02
Drop lens 1.5"	0.96	1.05

# VIA 4 RECESSED



DIRECT  
STATIC WHITE, BIOS

## AERA 3" FLEX MODULE

Values calculated based on 3500K and SDL lens option.

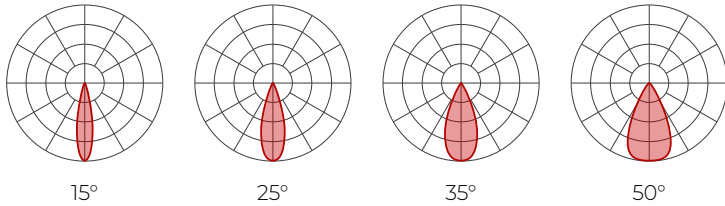

### Delivered lumens (LM)

CRI	80+ CRI				90+ CRI			
	15°	25°	35°	50°	15°	25°	35°	50°
BEAM								
10 W	1056	1127	1132	1003	987	1053	1058	937
14 W	1441	1539	1545	1370	1347	1438	1444	1280

### Efficacy (LM/W)

CRI	80+ CRI				90+ CRI			
	15°	25°	35°	50°	15°	25°	35°	50°
BEAM								
10 W	106	113	113	100	99	105	106	94
14 W	103	110	110	98	96	103	103	91

Please follow the multiplier tables to ensure correct lumen value.

CCT	
2700K	0.94
3000K	0.98
3500K	1
4000K	1.05
5000K	1.05

BAFFLE	
Bevel	1
Pinhole	0.92
Decorative bevel	1

LENS AT BAFFLE *	
SDL - Soft diffused lens, Solite	1
FDL - Frosted diffused lens	0.8
CL - Clear lens	1.1
NOL - No lens	1.1

ACCESSORIES AT LIGHT ELEMENT *	
LSDL - Soft diffused lens, Solite	1
LFDL - Frosted diffused lens	0.8
LS - Linear spread	0.84
HEX - Hex louver	0.86

\* When more than one lens or accessory is specified, multiply together the value of each lens and/or accessory, e.g. NOL + LSDL + LS = 1.1 x 1 x 0.84 = 0.924

## AERA 2" MODULE

Values calculated based on 3500K and SDL lens option.

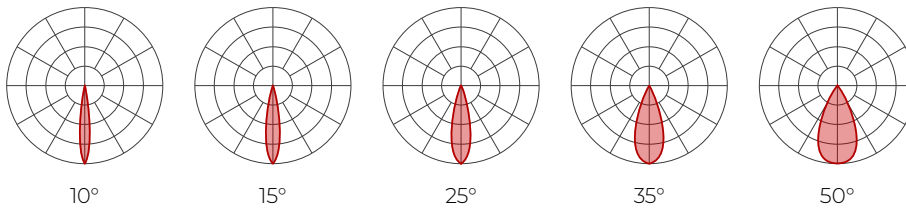

### Delivered lumens (LM)

CRI	80+ CRI					90+ CRI				
	10°	15°	25°	35°	50°	10°	15°	25°	35°	50°
BEAM										
7 W	589	654	714	705	676	550	611	667	659	632
10 W	792	880	961	949	910	740	822	898	887	850

### Efficacy (LM/W)

CRI	80+ CRI					90+ CRI				
	10°	15°	25°	35°	50°	10°	15°	25°	35°	50°
BEAM										
7 W	84	93	102	101	97	79	87	95	94	90
10 W	79	88	96	95	91	74	82	90	89	85

Please follow the multiplier tables to ensure correct lumen value.

CCT	
2700K	0.94
3000K	0.98
3500K	1
4000K	1.05
5000K	1.05

LENS AT BAFFLE	
SDL - Soft diffused lens, Solite	1
FDL - Frosted lens	0.8
CL - Clear lens	1.1

# VIA 4 RECESSED



DIRECT  
STATIC WHITE, BIOS

## BIOS

Three BIOS Circadian LED solutions are offered – Biological Static, Biological Dynamic, and Biological Tunable. Use the decision tree below to identify when and where to use BIOS Wellness LED Lighting Solutions.

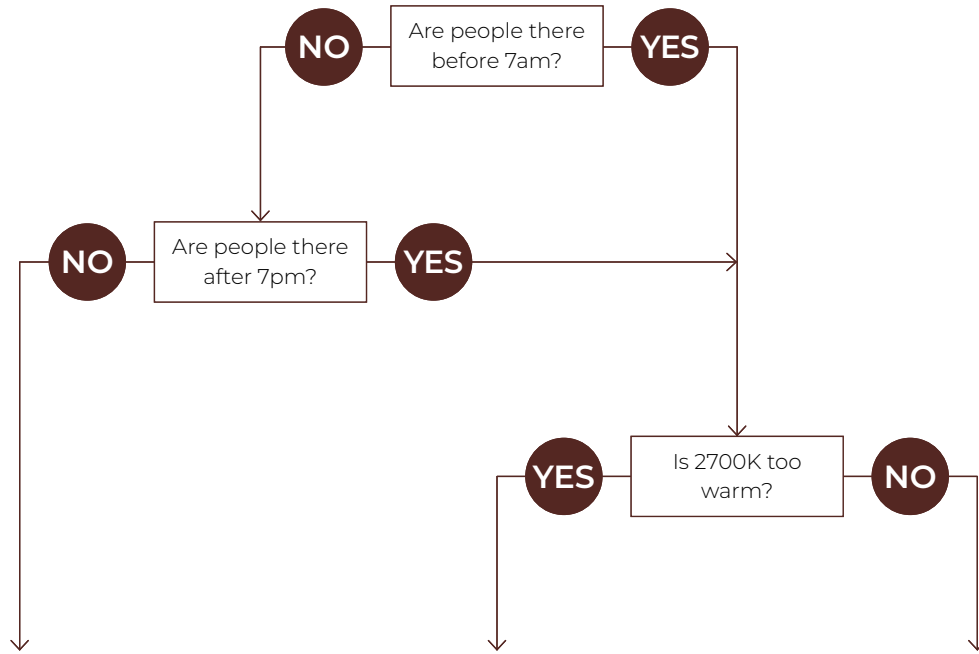

Biological Static BIOSST	Biological Dynamic BIOSDY	Biological Tunable BIOSTU
No CCT change when dimmed e.g. <b>40K</b> - 4000K stays as 4000K when dimmed	500K shift when dimmed e.g. <b>40K</b> - 4000K changes to 3500K when dimmed	Dims to 2700K e.g. <b>40K</b> - 4000K changes to 2700K when dimmed
Daytime solution	Daytime + evening solution	Daytime + evening solution
Spaces in operation during daytime hours, between 7am and 7pm	Spaces in operation overnight, after 7pm and before 7am, and when CCT color shift in the evening is not preferred	Suitable for spaces in operation overnight, after 7pm and before 7am, and where people do not sleep (CCT color shift in the evening is preferred)
E.g. offices, medical/dental offices	E.g. hospitals	E.g. offices, shiftwork

# VIA 4 RECESSED



DIRECT  
STATIC WHITE, BIOS

## Technical Specifications

### OPTICS

#### High-Efficiency Lambertian Optic (HLO)

The High-Efficiency Lambertian Optic (HLO) uses matte white reflectors to distribute LED output across 0.075" acrylic shielding, providing up to 88% transmission and good obscuration. Available with different lens position options, HLO has a spacing criterion of 1.16.

#### Asymmetric Refractive Optic (ARO2)

The Asymmetric Refractive Optic (ARO2) uses a sophisticated reflector combined with a matte beam-shaping film to create a smooth, effective downward light component without shadows or hot spots. It provides directional Gaussian light distribution with peak intensity at 20° above nadir and a 55° Full Width at Half Maximum (FWHM) beam angle. Microstructure material applied to the snap-in lens provides the precise refractive power and visual comfort, while achieving a high luminous efficacy.

#### Wall Wash Refractive Optic (WRO2)

The Wall Wash Refractive Optic (WRO2) delivers smooth vertical illumination with a gentle gradient and soft visual cut-off. Its exacting configuration creates a strong downward light component without shadows or hot spots and provides light distribution with peak intensity at 21° above nadir. Microstructure material applied to the snap-in lens provides the precise refractive power and visual comfort, while achieving a high luminous efficacy.

#### Widespread Direct Optic (WDO)

The Widespread Direct Optic (WDO) is designed to distribute light far and wide. As such, it has an excellent luminous efficacy, a light span that is 40% farther than that of our traditional HLO, and it maximizes spacing distance while still creating a sense of uniformity. The lens snaps into place and utilizes nano prismatic optics to mask the diodes that are actually emitting the light.

#### Low-Glare Optic (LGO)

The Low-Glare Optic (LGO) is designed to cut off high-angled light and control glare. The carefully crafted lens refracts light downward through its center from which it then disperses into a wide conical distribution that negates any illumination at about 40°. The LGO provides the visual comfort of a louver in a smooth acrylic lens.

#### Micro-Prismatic Optic (MPO)

The Micro-Prismatic Optic (MPO) delivers high-efficiency, low-glare illumination with UGR <17. Its precision-engineered lens, composed of thousands of tiny prisms, diffuses light to reduce glare, producing a ceiling plane that reads smooth from a distance while revealing subtle texture up close. The result is balanced, efficient illumination with a refined architectural presence.

### LIGHT SOURCE

#### Static white

Custom linear array of mid-flux LEDs are cartridge-mounted with quick-connect wiring to facilitate service and thermal management. Available in 2700K, 3000K, 3500K, 4000K, and 5000K with a minimum 80+ CRI and an option for 90+ CRI with elevated R9 value. Color consistency maintained to within 3 SDCM. All LEDs have been tested in accordance with IESNA LM-80-08 and the results have shown L80 lumen maintenance greater than 60,000 hours. Absolute product photometry is measured and presented in accordance with IESNA LM-79, unless otherwise indicated.

### BIOS

BIOS SkyBlue™ Technology is designed to provide the specific circadian stimulus to improve overall sleep quality, recovery during the night, and overall feelings of well-being. The non-visual light signals that stimulate our circadian system have peak intensity in the "sky blue" region. As the diagram below illustrates, BIOS SkyBlue technology shifts the peak LED spectral intensity (490 nm) to align better with the peak response of circadian stimulus. Also note the enhanced deep-red (near 660 nm) spectrum.

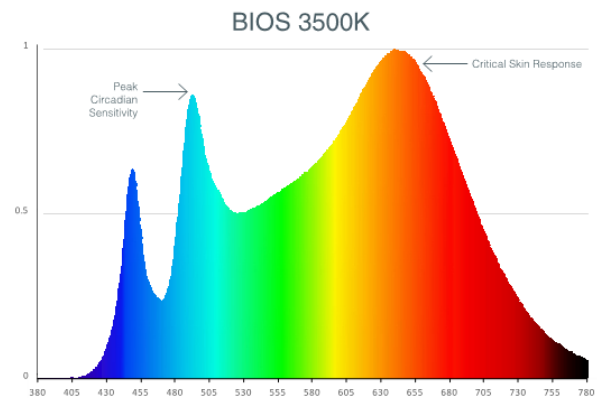

Three BIOS solutions are offered: BIOS Biological Static (BIOSST), BIOS Biological Dynamic (BIOSDY), and BIOS Biological Tunable (BIOSTU). See page 8 for details.

# VIA 4 RECESSED



DIRECT  
STATIC WHITE, BIOS

## LUMINAIRE LENGTH

Via 4 is available in standard lengths of 2' to 12' (up to 8' for MPO). Continuous runs are available for run lengths over 12' (8' for MPO). Exact run length must be noted in the product code. The minimum length is 2', and can be ordered in 1' and/or 1" increments. All individual sections are joined together onsite using the joiner kits provided. Lumenwerx offers joiner kits that are extremely simple to work with in the field and result in a fixture that appears virtually seamless with no light leak at any connection.

## ELECTRICAL

Factory-set, adjustable output current LED driver with universal (120-277 VAC) input. Dimmable from 100% to 1% with 0-10V dimming control. Rated life (90% survivorship) of 50,000 hours at 50°C max. ambient (and 70°C max. case) temperature. At maximum driver load: Efficiency > 84%, PF > 0.9, THD < 20%. Other specifiable options include Lutron Hi-Lume 1% Eco, eldoLED 1% ECOdrive 0-10V, eldoLED 0.1% SOLOdrive 0-10V, ELV, TRIAC, and DALI protocol drivers. All of our standard 0-10V drivers are NEMA 410 compliant. ELV and TRIAC dimming performance (including minimum dimming percentage) subject to dimmer selection.

## PoE

Depending on the PoE manufacturer selected, Lumenwerx will install the node in factory as either integral to the luminaire or as a remote module. Factory programming of the PoE node may or may not enable the following functionalities: lumen package, DUO (tunable white), QUADRO (RGBW), emergency battery backup, and sensor integration. These must be addressed and evaluated on a case-by-case basis.

## ELECTRICAL SECTION OPTIONS

Electrical section options are available for fixtures specified as multi circuit (#MC). With MC, specify the total number of circuits (#), including any circuits required for optional electrical sections. A drawing is required to specify the layout. Please consult factory for custom configurations.

## Electrical sections

Options include emergency-powered (#EC##), night light (#NL##), daylight (#DL##), and generator transfer device (#GTD##) sections. Specify the quantity (#), as well as the section length in inches (##).

Example 1: A 32' Direct fixture with two 8' emergency-powered sections on a second circuit.  
Code: 2MC-2EC96

Example 2: A 24' Direct fixture with one 4' generator transfer device section.  
Code: 1MC-1GTD48

## Battery

Each emergency battery (#EMB) powers a 4' section. All batteries will be on the same circuit. Specify the number of batteries (#) required.

Factory installed long life, high temperature, maintenance-free Lithium-Ion battery pack with self-test functionality, test switch and charge indicator. Minimum of 90 minutes operation, up to 1000 lumens per 4' (25°C) emergency lighting output and recharge time of 24 hours.

## MOUNTING

Recessed fixtures can be mounted into exposed or concealed T-bar or tegular ceiling, as well as in ceilings with trim, trimless, or mud flange options.

## FINISH

**Interior:** 95% reflective matte powder coated white paint

**Exterior:** Matte white or matte black powder coating. Custom finishes are also available.

## CONTROLS

Lumenwerx offers several options for integrating occupancy and daylight harvesting controls in our luminaires. For latest information on sensors, click [here](#).



## Standalone controls

An integrated standalone sensor controls the luminaire in which it is installed. Depending on the length, more than one sensor may be necessary and may control the entire luminaire, or just a section of it. These controls operate independently. Unless otherwise agreed, sensor location, blank size, and functionality of the sensor within the luminaire are selected by Lumenwerx. See client drawings for details. Three types are available:

OMS: An integral Passive InfraRed (PIR) sensor turns luminaires on and off automatically with field-adjustable time out period. No wall control is used. Coverage pattern for large motion has a 12' diameter with the sensor mounted 8' above the floor; for small motion, the pattern has an 8' diameter. Typically, one sensor is required for every 10' of a continuous luminaire run.

ODS: An integral, daylight harvesting sensor with closed-loop operation dims the luminaire in which it is installed in order to compensate for available daylight. The sensor measures the combination of daylight and luminaire light reflected from horizontal surfaces below the luminaire. Initial onsite calibration is required via the use of provided remote control.

OCS: Both an occupancy and a daylight sensor are installed in the luminaire.

# VIA 4 RECESSED



DIRECT  
STATIC WHITE, BIOS

## Connected controls

With connected controls, sensors or nodes installed in the luminaire form part of a larger control system infrastructure from manufacturers such as: Lutron, Encelium, Cooper Wavelinx, Acuity nLight, Casambi, Legrand, and others. These connected controls allow for a scalable system providing features like occupancy and daylight control, manual control, scheduling and configuration of various zones and scenes. Energy reporting and system monitoring are also possible. Specific capabilities depend on the control system being used.

Lumenwerx installs the components (sensors, nodes, power packs, etc) which may be supplied to us by a third party, or procured directly by Lumenwerx, depending on the control system manufacturer.

Lumenwerx is solely responsible for the installation of specified components; the controls manufacturer is responsible for performance of the control system.

To indicate a Lumenwerx luminaire with connected controls, identify the specific onsite control system to be integrated into the luminaires using the ordering code. Due to the diversity of components, you must contact factory to assure complete compatibility with intended control system and to fully specify the luminaire.

Complete control specifications, sensor/node/power pack layout, and narrative for the control system are required for Lumenwerx to create shop drawings and submittals.

## AERA FLEX MODULE

Aera Flex is a round spotlight that rotates 355° and tilts 90°, available in four beam angles of 15°, 25°, 35°, and 50°. LED light source CCT options are 2700K, 3000K, 3500K, 4000K, and 5000K available in either 80+ CRI or 90+ CRI. Offered in 4.5" height with three baffle options: bevel, pinhole, and decorative bevel. Aera Flex is available in a wide range of colors.

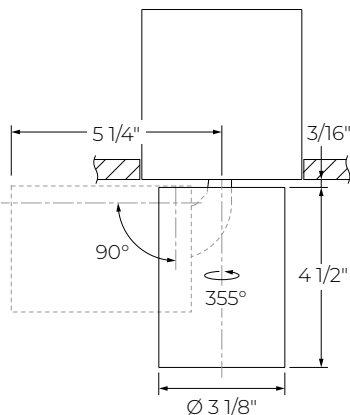

Aera 3" Flex

## AERA MODULE

Aera Downlight is available in five beam angles of 10°, 15°, 25°, 35°, and 50°. LED light source CCT options are 2700K, 3000K, 3500K, 4000K, and 5000K available in either 80+ CRI or 90+ CRI. Aera Downlight is available in a wide range of colors.

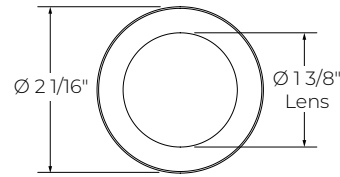

Aera 2"

## CONSTRUCTION

- Housing:** Extruded aluminum, up to 90% recycled content
- Interior brackets:** Die-formed cold rolled sheet steel
- Joining system:** Die-cast zinc
- Reflectors:** Die-formed cold rolled steel, 95% reflective matte white painted
- Lens:** Acrylic
- Drop lens:** Extruded with glued end caps
- Recessed flanges:** Extruded aluminum, up to 90% recycled content
- Mud flange:** Extruded aluminum, up to 90% recycled content
- Slip-through bracket:** Die-formed galvanized sheet
- End plate:** Die-formed cold rolled sheet steel

## WEIGHT

- 4':** 11.45 lbs - 5.2 kg
- 8':** 23.13 lbs - 10.5 kg
- 12':** 34.58 lbs - 15.7 kg

## CERTIFICATIONS

- ETL:** Rated for indoor dry/damp locations. Conforms to UL Standard 1598 and certified to CAN/CSA Standard C22.2 No. 250.0.
- Chicago Plenum:** City of Chicago Approved (CCEA) when specified with CP option.
- IC rated:** Suitable for direct contact with insulation
- Declare:** [LBC Red List Approved](#)

## WARRANTY

Lumenwerx provides a five-year limited warranty on electrical and mechanical performance of the luminaires, including the LED boards, drivers, and auxiliary electronics. Lumenwerx will repair or replace defective luminaires or components at our discretion, provided they have been installed and operated in accordance with our specifications. Other limitations apply, please refer to the full warranty on our website.