

VIA 4 WALL

DIRECT/INDIRECT, DIRECT, INDIRECT
CHROMAWERX - QUADRO - RGBW

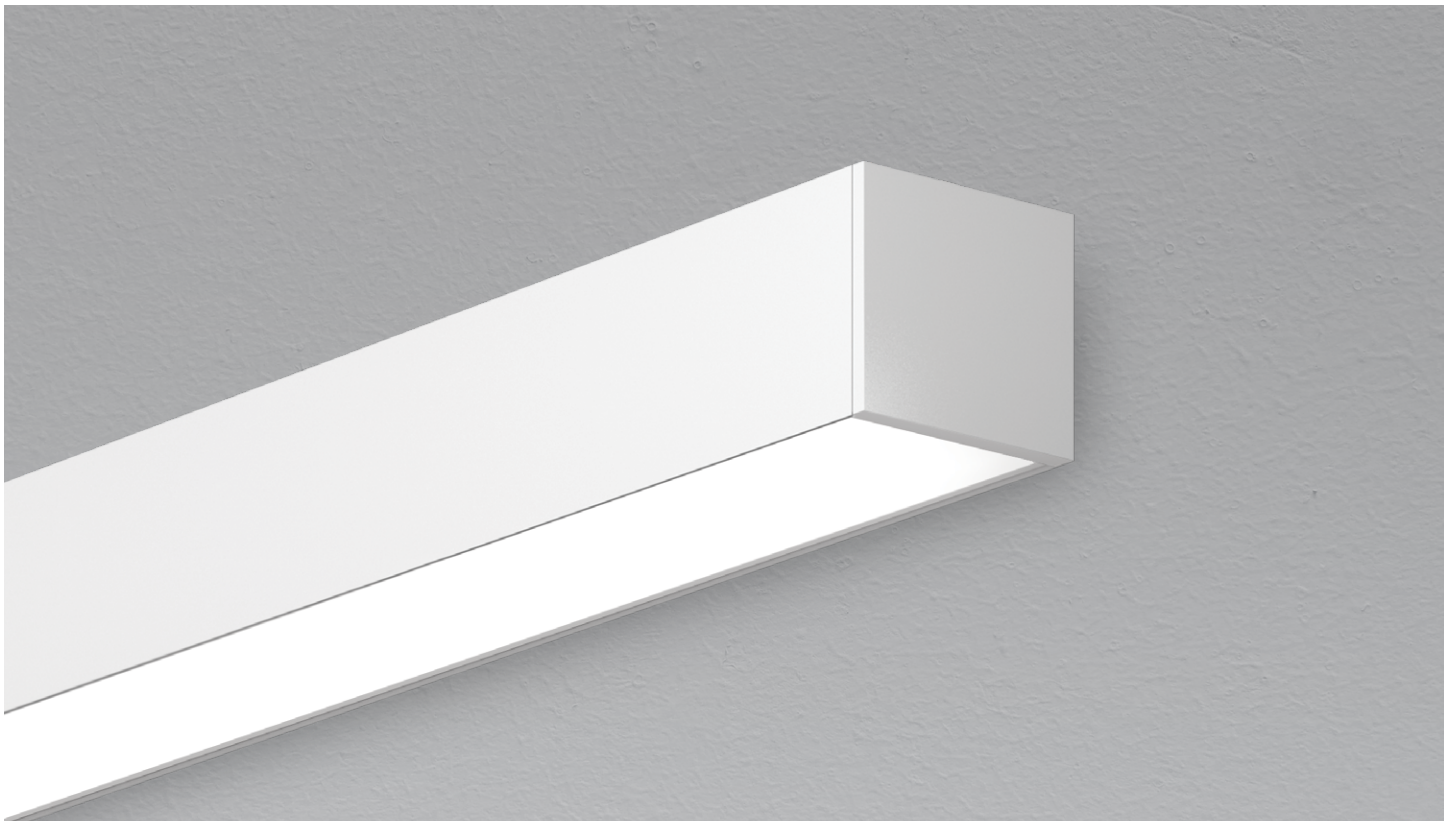

Declare.



Our elegant, flexible Via family is composed of linear, pendant, surface, recessed, and wall mounted luminaires. Each lighting fixture can be installed as a discrete luminaire or in continuous runs or patterns. Via 4 Wall is offered with Lambertian or asymmetric optics.

Lens Positions

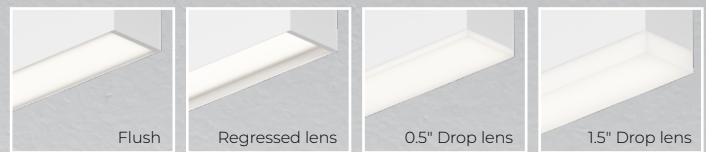

DIRECT



HLO ARO2

INDIRECT



TIO HLO ARO2

VIA 4 WALL

DIRECT/INDIRECT, DIRECT, INDIRECT
CHROMAWERX - QUADRO - RGBW



Project: _____

Type: _____

Order Guide

LUMINAIRE ID	DISTRIBUTION	DIRECT OPTIC Specify NA for Indirect fixture	LENS POSITION Specify NA for Indirect fixture	INDIRECT OPTIC Specify NA for Direct fixture	LIGHT SOURCE ⁴
VIA4W					
VIA4W - Via 4" Wall	DI - Direct/Indirect D - Direct I - Indirect	HLO - High-Efficiency Lambertian Optic ARO2 - Asymmetric Refractive Optic NA - Not applicable	FH ¹ - Flush RG ¹ - Regressed 0.5D ¹ - 0.5" drop 1.5D ¹ - 1.5" drop NA ¹ - Not applicable ¹ For HLO, specify FH, RG, 0.5D, or 1.5D. ¹ For ARO2, specify FH. ¹ For an Indirect fixture, specify NA.	TIO ² - Translucent Indirect Optic HLO ³ - High-Efficiency Lambertian Optic ARO2 ³ - Asymmetric Refractive Optic NA - Not applicable ² Available only with Direct/Indirect. ³ Not available with Direct/Indirect.	QUADRO - RGBW 4-channel control RS - Red solid GS - Green solid BS - Blue solid ⁴ Static white, BIOS, Chromawerx SOLA, and DUO also available. Consult other spec sheets.

WHITE CRI Specify NA for solid colors	WHITE COLOR TEMP. Specify NA for solid colors	DIRECT OUTPUT WATTAGE ⁵ Specify NA for indirect fixture	INDIRECT OUTPUT WATTAGE ⁷ Specify NA for Direct fixture	LUMINAIRE LENGTH	VOLTAGE	
80CRI - 80+ CRI 90CRI - 90+ CRI NA - Not applicable	27K - 2700K 30K - 3000K 35K - 3500K 40K - 4000K 50K - 5000K NA - Not applicable	HLO ARO2 NA - Not applicable ⁵ See page 3 for dedicated white channel lumen outputs. ⁶ Not available with solid colors.	8WF - 8 W/ft output 10WF ⁶ - 10 W/ft output 12WF ⁶ - 12 W/ft output 5WF - 5 W/ft output 7WF ⁶ - 7 W/ft output ⁷ See page 3 for dedicated white channel lumen outputs. ⁸ Not available with solid colors.	5WF - 5 W/ft output 7WF ⁸ - 7 W/ft output NA - Not applicable ⁹ Minimum length is 4'.	#FT#IN ⁹ - Specify nominal length (#) in 1' and/or 6" increments Standard nominal lengths: Single units: 4' to 12' Continuous runs: lengths over 12'	120V - 120V 277V - 277V UNV - 120V-277V

DRIVER ¹⁰	ELECTRICAL	MOUNTING	FINISH	OPTION
QUADRO DMX ^{11,12} - DMX Solid colors D1 - 1% 0-10V DA ¹² - DALI ¹⁰ PoE (Power-over-Ethernet) compatible. Consult factory for details. ¹¹ For more information, see pages 6 to 11. ¹² On-site commissioning is required.	1C - 1 circuit	DMB - Drywall mounting bracket	W - Matte white AL - Aluminum B - Matte black CF# - Custom finish, specify RAL#	FU120 - Fuse 120V FU277 - Fuse 277V NA - None

Accessories

Optional, order separately

DMX WALL CONTROLLER ^{13,14}
WC1W##FT - Single zone wall controller white WC1B##FT - Single zone wall controller black WC2W##FT - 3 zone wall controller white WC2B##FT - 3 zone wall controller black ¹³ Specify wire length (##) in feet. ¹⁴ Available with DMX only. For more information, see pages 6 to 11, or consult factory.

VIA 4 WALL



DIRECT/INDIRECT, DIRECT, INDIRECT
CHROMAWERX - QUADRO - RGBW

Dimensions

Flush Lens

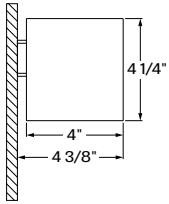

Regressed Lens¹

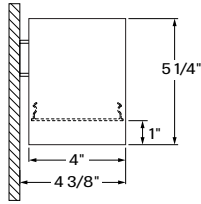

0.5" Drop Lens¹

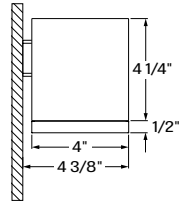

1.5" Drop Lens¹

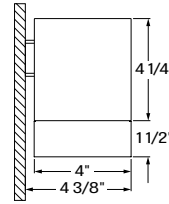

¹ Only available with HLO direct lens.

Photometrics

Dedicated white channel lumen outputs are calculated with only white light on, and based on a 4' fixture at 3500K for all optics.

DIRECT OPTICS

OPTIC	W/FT	LM/FT
HLO-FH	8	325
	10	400
	12	500
HLO-RG	8	225
	10	300
	12	350
HLO-0.5D	8	325
	10	400
	12	500
HLO-1.5D	8	325
	10	400
	12	500
ARO2	5	225
	7	300

INDIRECT OPTICS

OPTIC	W/FT	LM/FT
TIO	5	225
	7	325
HLO	5	350
	7	500
ARO2	5	225
	7	300

Technical Specifications

DIRECT OPTICS

High-Efficiency Lambertian Optic (HLO)

The High-Efficiency Lambertian Optic (HLO) uses matte white reflectors to distribute LED output across 0.075" acrylic shielding, providing up to 88% transmission and good obscuration. Available with different lens position options, HLO has a spacing criterion of 1.16.

Asymmetric Refractive Optic (ARO2)

The Asymmetric Refractive Optic (ARO2) uses a sophisticated reflector combined with a matte beam-shaping film to create a smooth, effective downward light component without shadows or hot spots. It provides directional Gaussian light distribution with peak intensity at 20° above nadir and a 55° Full Width at Half Maximum (FWHM) beam angle. Microstructure material applied to the snap-in lens provides the precise refractive power and visual comfort, while achieving a high luminous efficacy.

INDIRECT OPTICS

Translucent Indirect Optic (TIO)

The Translucent Indirect Optic (TIO) is composed of a horizontal LED array that has a translucent lens to mask pixilation from the diodes. TIO has a 100° spread in the indirect that is ideal when the fixture is mounted farther away from the ceiling.

High-Efficiency Lambertian Optic (HLO)

The High-Efficiency Lambertian Optic (HLO) uses matte white reflectors to distribute LED output across 0.075" acrylic shielding, providing up to 88% transmission and good obscuration. HLO has a spacing criterion of 1.16.

Asymmetric Refractive Optic (ARO2)

The Asymmetric Refractive Optic (ARO2) uses a sophisticated reflector combined with a matte beam-shaping film to create a smooth, effective downward light component without shadows or hot spots. It provides directional Gaussian light distribution with peak intensity at 20° above nadir and a 55° Full Width at Half Maximum (FWHM) beam angle. Microstructure material applied to the snap-in lens provides the precise refractive power and visual comfort, while achieving a high luminous efficacy.

LIGHT SOURCE

Custom linear array of mid-flux LEDs, comprised of an alternation of an RGB and a dedicated white LED. The white LED is used for when a static white CCT is required in the space. RGB LEDs are tightly binned for excellent color control between fixtures. The white LEDs have been tested in accordance with IESNA LM-80-08 and the results have shown L80 lumen maintenance greater than 60,000 hours. Absolute product photometry is measured and presented in accordance with IESNA LM-79, unless otherwise indicated.

Chromawerx QUADRO

Chromawerx QUADRO is a four-channel control that operates an RGBW LED array and addresses the need for more expressive color in architectural applications. The DMX driver supports familiar programming tools for both dynamic multi-hued color and precise white color point control. While a typical user interface will be a DMX controller by others, Lumenwerx also offers a simple control station for stand-alone color changing applications.

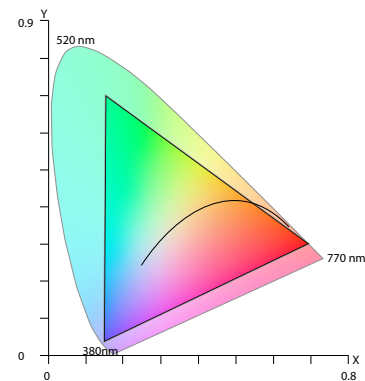

The above diagram overlays the full gamut of colors attainable with the RGBW on top of the CIE 1931 color space. Any color point inside of the triangle can be obtained by setting the correct output levels for each of the individual red, green, blue, and white channels.

LUMINAIRE LENGTH

Via 4 is available in standard lengths of 4' to 12'. Continuous runs are available for run lengths over 12'. Exact run length must be noted in the product code. The minimum length is 4', and can be ordered in 1' and/or 6" increments. All individual sections are joined together onsite using the joiner kits provided. Lumenwerx offers joiner kits that are extremely simple to work with in the field and result in a fixture that appears virtually seamless with no light leak at any connection.

VIA 4 WALL



DIRECT/INDIRECT, DIRECT, INDIRECT
CHROMAWERX - QUADRO - RGBW

ELECTRICAL

DMX

Factory-set, adjustable output current, multi-channel LED driver with universal (120-277 VAC) input. Using DMX wall controls (optionally supplied by Lumenwerx) or an existing DMX control system, four channels of LEDs (Red/Green/Blue/White) are independently adjustable. Each DMX driver has multiple output channels that can be independently addressed at the factory or on-site using built-in RDM (Remote Device Management) functionality. Dimming range from 100%-0%. At maximum driver load, efficiency<89%, PF>0.9, THD<20%.

PoE

Depending on the PoE manufacturer selected, Lumenwerx will install the node in factory as either integral to the luminaire or as a remote module. Factory programming of the PoE node may or may not enable the following functionalities: lumen package, DUO (tunable white), QUADRO (RGBW), emergency battery backup, and sensor integration. These must be addressed and evaluated on a case-by-case basis.

MOUNTING

Fixtures may be horizontally mounted to the wall using a bracket. For long runs, a minimum of 6" from adjacent wall is required.

FINISH

Interior: 95% reflective matte powder coated white paint
Exterior: Matte white, matte black or aluminum powder coating. Custom finishes are also available.

CONSTRUCTION

Housing: Extruded aluminum, up to 90% recycled content
Interior brackets: Die-formed cold rolled sheet steel
Joining system: Die-cast zinc
Reflectors: Die-formed cold rolled steel, 95% reflective matte white painted
Lens: Acrylic
Drop lens: Extruded with glued end caps
End caps: Die-cast aluminum

WEIGHT

Direct/Indirect	Direct or Indirect
4': 13.66 lbs - 6.2 kg	4': 11.45 lbs - 5.2 kg
8': 27.53 lbs - 12.5 kg	8': 23.13 lbs - 10.5 kg
12': 41.41 lbs - 18.8 kg	12': 34.58 lbs - 15.7 kg

CERTIFICATIONS

ETL: Rated for indoor dry/damp locations. Conforms to UL Standard 1598 and certified to CAN/CSA Standard C22.2 No. 250.0.
Declare: [LBC Red List Approved](#)

WARRANTY

Lumenwerx provides a five-year limited warranty on electrical and mechanical performance of the luminaires, including the LED boards, drivers, and auxiliary electronics. Lumenwerx will repair or replace defective luminaires or components at our discretion, provided they have been installed and operated in accordance with our specifications. Other limitations apply, please refer to the full warranty on our website.
Wall controllers are covered by the manufacturer warranty.

QUADRO DMX SPECIFICATION

A qualified DMX integrator is required to assure proper installation and commissioning of the DMX network. **When placing the PO, please provide the contact information of your DMX integrator.**

Please answer the following questions to help us identify your DMX network requirements.

YES

Do you require a wall controller provided by Lumenwerx?

NO

DMX controller supplied by Lumenwerx

DMX control system supplied by others. Lumenwerx will supply DMX-enabled fixtures with default DMX addressing. See following pages for technical DMX informations. ✓

How many zones do you have?

A zone consists of one or more luminaires behaving identically.



1 Zone



2 Zones

How to calculate the required number of drivers:

per 4' fixture
Driver
1x driver
Less than 12.5W/ft, direct only

per 4' fixture
Driver Driver
2x driver
Above 12.5W/ft or for all direct/indirect fixture

To Calculate # of drivers

1 Zone

2 to 3 Zones

4 or more Zones

Do you have more than 32 drivers in total?

NO

YES

Order a standard Lumenwerx wall controller type 1.

WALL CONTROLLER

WC1W - Single zone wall controller white
WC1B - Single zone wall controller black

Add the control code at the end of your order code. Please provide a fixture layout or RCP (Reflected Ceiling Plan) showing the locations of the DMX fixtures, zones and the DMX wall controller. Refer to your DMX integrator for the installation. ✓

Subject to factory evaluation. Please contact our controls specialist at controls@lumenwerx.com. Additional cost and equipment will be required. ✓

NO

YES

Order a standard Lumenwerx wall controller type 2.

WALL CONTROLLER

WC2W - 3 zone wall controller white
WC2B - 3 zone wall controller black

Add the control code at the end of your order code. Please provide a fixture layout or RCP (Reflected Ceiling Plan) showing the locations of the DMX fixtures, zones and the DMX wall controller. Refer to your DMX integrator for the installation. ✓

Subject to factory evaluation. Please contact our controls specialist at controls@lumenwerx.com. Additional cost and equipment will be required. ✓

Subject to factory evaluation and approval. Please contact our controls specialist at controls@lumenwerx.com. Additional cost and equipment will be required. ✓

VIA 4 WALL

DIRECT/INDIRECT, DIRECT, INDIRECT
CHROMAWERX - QUADRO - RGBW



GENERIC DMX NETWORK ARCHITECTURE

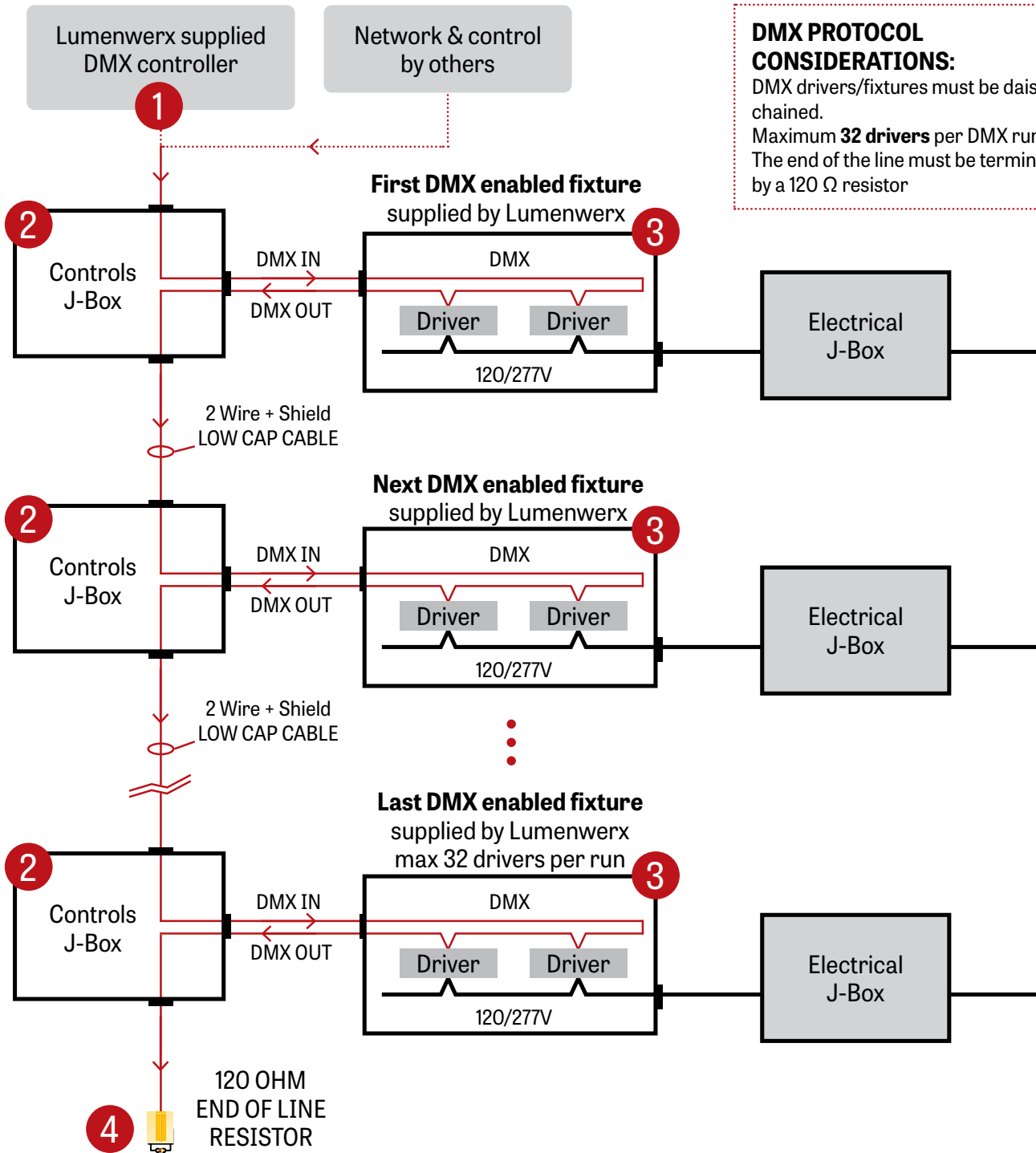

DMX PROTOCOL CONSIDERATIONS:
DMX drivers/fixtures must be daisy chained.
Maximum **32 drivers** per DMX run.
The end of the line must be terminated by a 120 Ω resistor

VIA 4 WALL

DIRECT/INDIRECT, DIRECT, INDIRECT
CHROMAWERX - QUADRO - RGBW



1 LUMENWERX SUPPLIED DMX CONTROLLER

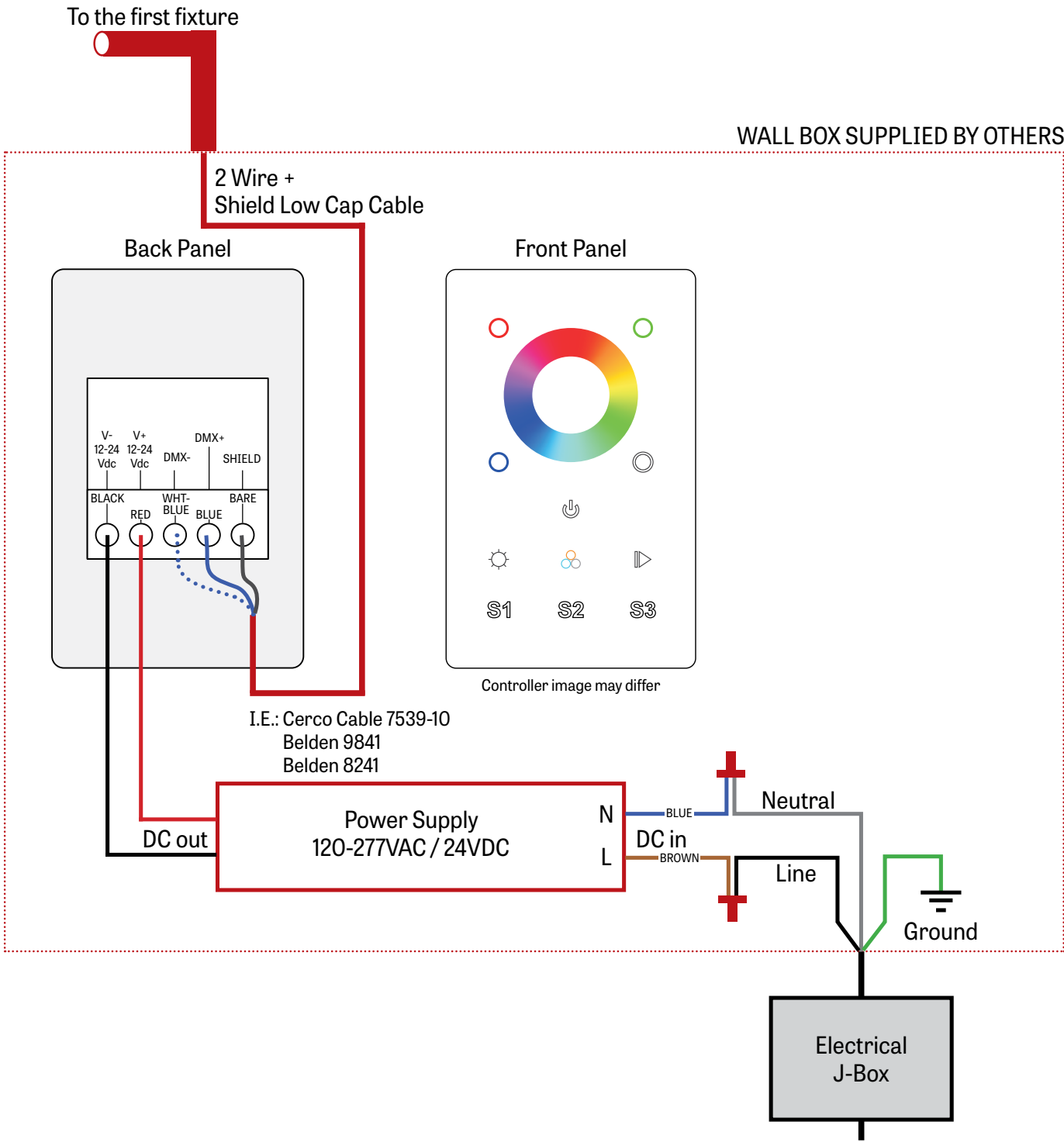

2 J-BOX DMX DAISY CHAIN DETAIL

Low capacitance DMX cable from previous fixture

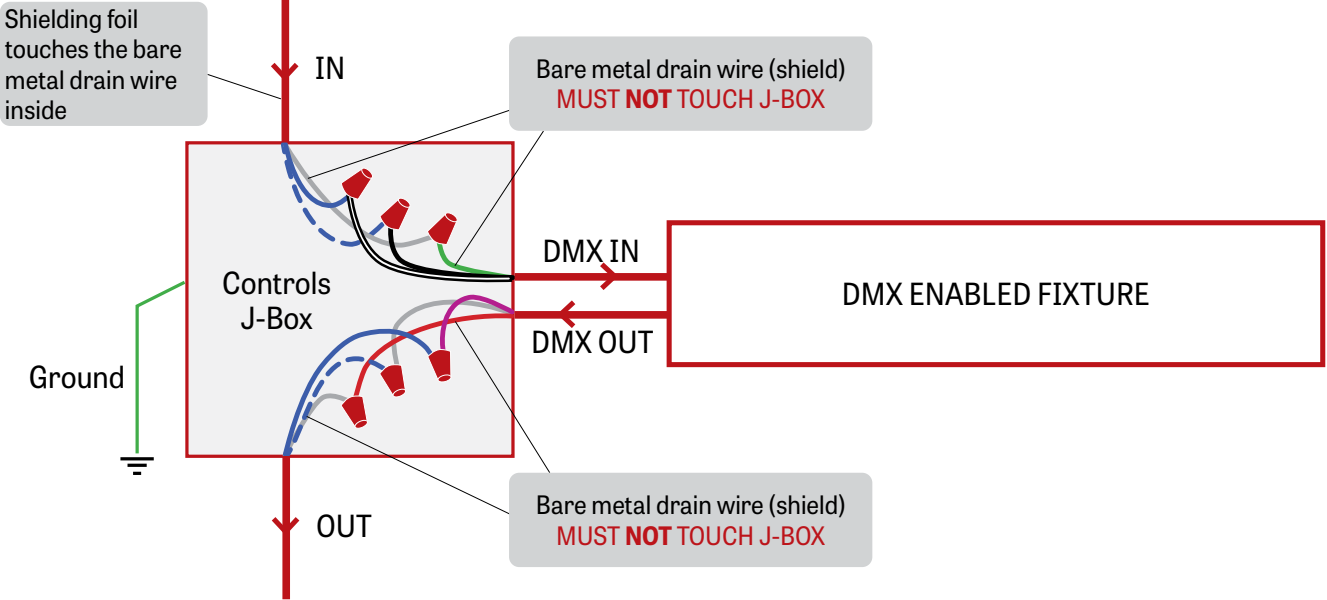

Low capacitance DMX cable to next fixture

3 DMX CONNECTION PENDANT & WALL

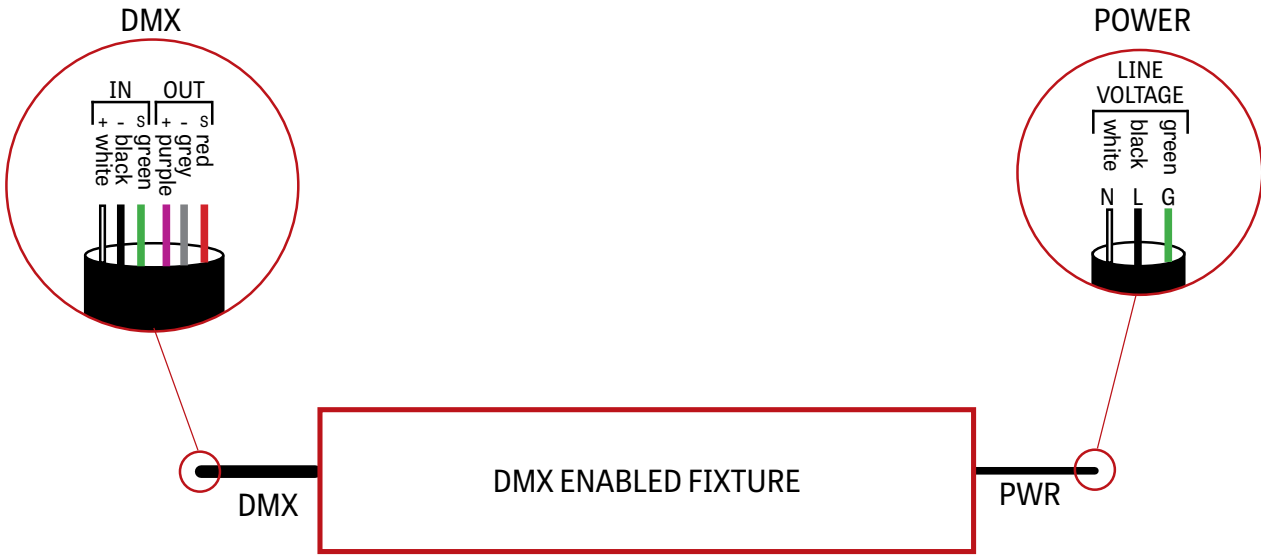

VIA 4 WALL

DIRECT/INDIRECT, DIRECT, INDIRECT
CHROMAWERX - QUADRO - RGBW



4 DMX LAST FIXTURE DETAIL

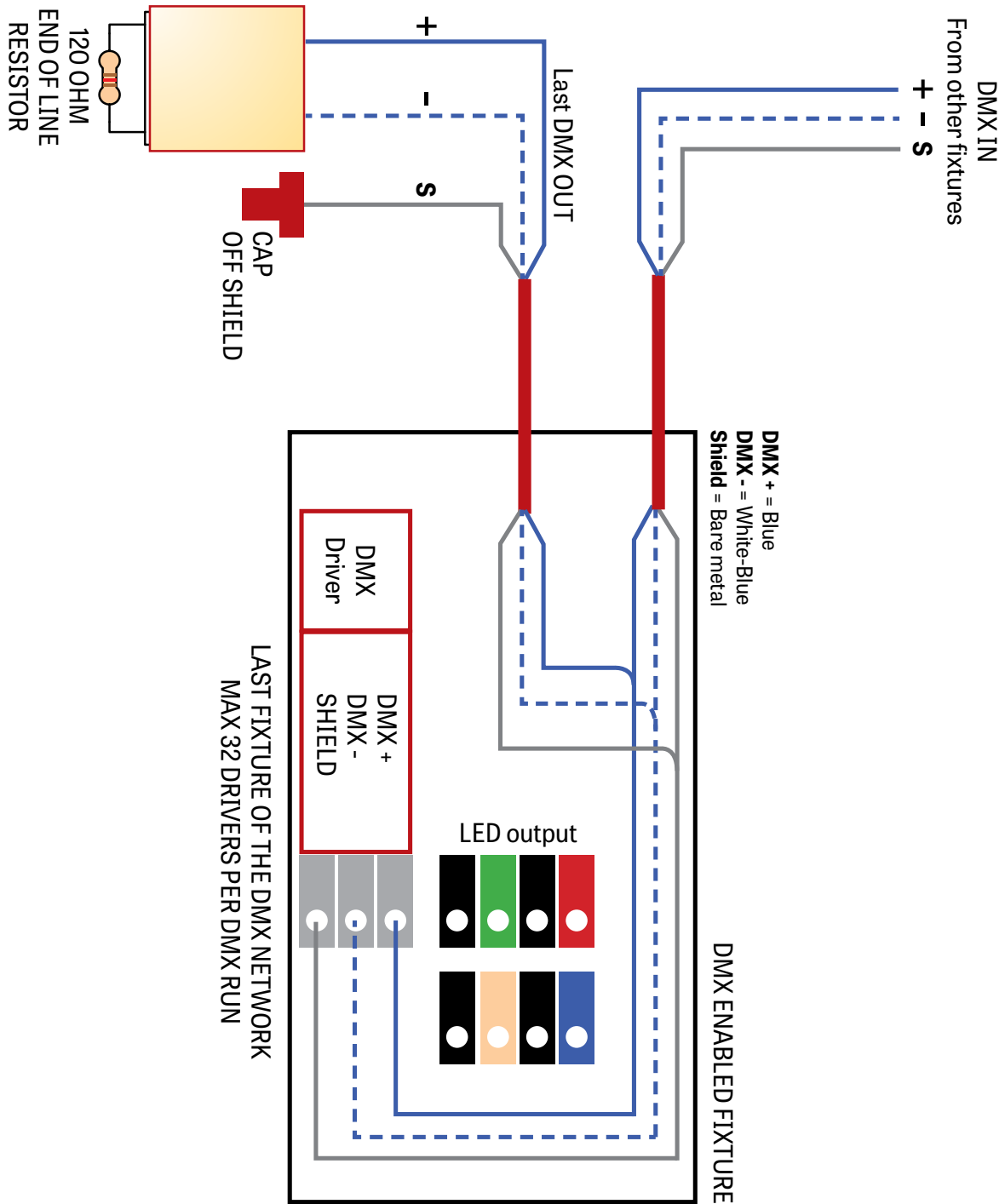

DMX WALL CONTROLLER

WC1

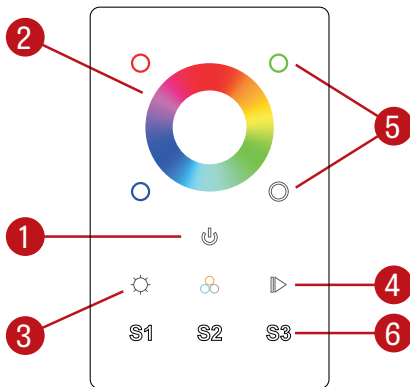

- (1) Power: Use this button to turn ON or OFF the RGBW fixture.
- (2) Color Wheel: The wheel is used to rapidly select a color (RGB colors only).
- (3) Brightness (RGB): Hold down this button to either increase or decrease the brightness of the current RGB selection. White will not be affected by the RGB brightness button.
- (4) Color Cycle: This button will start an animation, rotating between Reds Greens and Blues, the arrows allow the user to speed up or slow down the animation.
- (5) Individual Colors: By pressing and holding a color it will be possible to brighten or dim it. Quickly pressing a color will turn it OFF or turn it ON to its previous dim level.
White: In order to activate or deactivate and dim the White channel, the White button needs to be used.
- (6) Scenes: By holding down one of the scenes button, the current color selection is saved. It can be later accessed by quickly pressing on one of the Scene buttons.

WC2

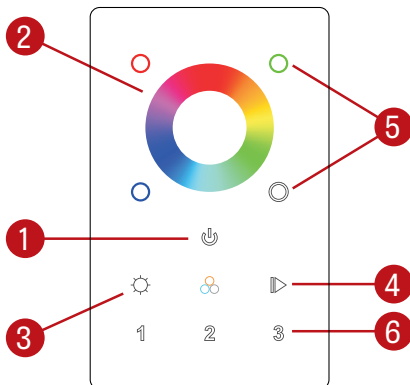

- (1) Power: Use this button to turn ON or OFF the RGBW fixture.
- (2) Color Wheel: The wheel is used to rapidly select a color (RGB colors only).
- (3) Brightness: Hold down this button to either increase or decrease the brightness of the current RGB selection. White will not be affected by the RGB brightness button.
- (4) Color Cycle: This button will start an animation, rotating between Reds Greens and Blues, the arrows allow the user to speed up or slow down the animation.
- (5) Individual Colors: By pressing a color it will be possible to brighten or dim that specific color.
White: In order to activate or deactivate and dim the White channel, the White button needs to be used.
- (6) Zone: By holding down one of the zone buttons, a zone can be selected and controlled.

Default DMX Addresses:

- 1 Red
- 2 Green
- 3 Blue
- 4 White