

VIA 4 SEAL

PENDANT

CHROMAWERX - SOLA, DUO

SEALWERX SERIES

 Lumenwerx



The Via Seal Collection is engineered for environments where performance is critical. Designed to withstand the harshest conditions, Via Seal fixtures feature ingress protection ratings from IP44 to IP66 and an impact protection rating of IK08. These luminaires provide robust defense against dust, water, and physical damage, all while maintaining the visual continuity and design flexibility of the sleek Via product line.

IP RATINGS

- IP66
- IP65
- IP65EC
- IP64
- IP54
- IP44

LIGHT SOURCE

- SOLA - Dim-to-Warm
- DUO - Tunable White

UP TO

IK08



SENSORS
For latest information on sensors, click [here](#).



Via Seal Brochure

VIA 4 SEAL

PENDANT

CHROMAWERX - SOLA, DUO



Project: _____

Type: _____

SEALWERX SERIES

Order Guide

LUMINAIRE ID	DISTRIBUTION	ENVIRONMENT ^{1,2}	DIRECT OPTIC	INDIRECT OPTIC Specify NA for Direct fixture	LIGHT SOURCE ³	
V4SEALP						
V4SEALP - Via 4" Seal Pendant	D - Direct DI - Direct/Indirect	<u>Direct:</u> IP66 - IP66-Rated IP65EC - IP65-Rated Electrical Components IP64 - IP64-Rated IP54 - IP54-Rated IP44 - IP44-Rated	<u>Direct/Indirect:</u> IP65 - IP65-Rated IP64 - IP64-Rated IP44 - IP44-Rated	EPDO - Environmentally Protected Direct Optic ASDO - Asymmetric Soft Direct Optic	EPIO - Environmentally Protected Indirect Optic ASIO - Asymmetric Soft Indirect Optic WIO2 - Widespread Indirect Optic NA - Not applicable	SOLA - Dim-to-warm single channel control 35K to 22K DUO - Tunable white 2-channel control 65K to 27K
¹ See page 4 to 5 for more information on the features and installation details for each environment option. ² Fixture must be installed horizontally with direct lens facing down.					³ Static white and BIOS also available. Consult factory for RGBW.	

CRI	DIR. LUM. PACK.	INDIR. LUM. PACK. Specify NA for Direct fixture	LUMINAIRE LENGTH	VOLTAGE	DRIVER ⁵
80CRI - 80+ CRI 90CRI - 90+ CRI	500LMF - Low output 500 lm/ft 750LMF - Medium output 750 lm/ft 1000LMF - High output 1000 lm/ft	500LMF - Low output 500 lm/ft 750LMF - Medium output 750 lm/ft 1000LMF - High output 1000 lm/ft NA - Not applicable	#FT#IN ⁴ - Specify nominal length (#) in 1" and/or 1" increments Standard nominal lengths: Single units: 2' to 12' Continuous runs: lengths over 12' ^{4a} - Minimum 2' for Direct. ^{4b} - Minimum 3' for Direct/Indirect. ^{4c} - Minimum 4' for DMX.	120V - 120V 277V - 277V UNV - 120V-277V	<u>SOLA</u> SD1 - Single 0-10V input <u>DUO</u> DMX ^{6,7} - DMX DDA ⁷ - DALI DT6 DDA8 ⁷ - DALI DT8 DD1 - Dual 0-10V input for CCT/intensity LD2 ⁷ - Lutron DALI-2 digital
⁵ See page 4 to 5 for driver temperature ranges. ⁶ For more information, see pages 12 to 17. ⁷ On-site commissioning is required.					

ELECTRICAL	POWER FEED	MOUNTING ⁸	FINISH	OPTION
IC	TF			
IC - 1 circuit	TF - Top feed	STS - Stem, standard STC() - Stem, custom ⁸ Standard canopies are black for black fixtures, and white for all other finishes. See page 3 for full details on standard and custom options.	W - Matte white AL - Aluminum B - Matte black WA - White antimicrobial Silverwerx CF# - Custom finish, specify RAL#	CRF ⁹ - Corrosion-resistant finish NATA ⁹ - Natatorium finish MAR ⁹ - Marine finish NA - None ⁹ Only available with IP66, IP65 and IP65EC environment options.

Accessories

Optional, order separately

WALL CONTROLLER ¹⁰

DMX	DDI
WCW##FT ¹¹ - DMX wall controller white WCB##FT ¹¹ - DMX wall controller black	TWCW##FT ¹² - Dual 0-10V wall controller white TWCB##FT ¹² - Dual 0-10V wall controller black
¹⁰ Specify wire length (##) in feet. ¹¹ Available with DMX only. For more information, see pages 12 to 17, or consult factory. ¹² Available with DDI only. For more information, see page 18, or consult factory.	

VIA 4 SEAL

PENDANT

CHROMAWERX - SOLA, DUO



SEALWERX SERIES

Pendant Mounting Code

Standard

For a standard mounting, please refer to the information below.

MOUNTING

STS - Stem, standard

- Ø 5" for power canopy
- Ø 5" for non-power canopy
- Canopies are black for black fixtures, and white for all other fixture finishes
- Stem finish is the same color as fixture
- Stem length is 18"
- Stem is not field adjustable
- Power cord is black for black fixtures, and white for all other fixture finishes

Custom

Stem

For a custom mounting, specify the options in the parentheses.

Example: STC(5NPC-36IN-W-STW-SLS)

MOUNTING

STC()

	NON-POWER CANOPY SIZE	STEM LENGTH	CANOPY FINISH	STEM COLOR	OPTION
STC	5NPC - Ø 5" non-power canopy	18IN - 18" 36IN - 36" #IN ¹ - Specify length in inches ¹ Minimum length is 6". Maximum length is 72". Stem is not field adjustable.	W - Matte white AL - Aluminum B - Matte black CF# - Custom finish, specify RAL#	STW - Matte white STAL - Aluminum STB - Matte black STCF# - Custom finish, specify RAL#	SLS - Sloped ceiling for stem NA - None

Dimensions

DIRECT

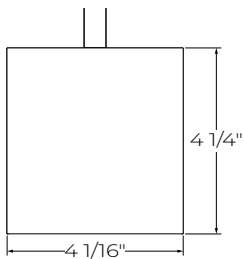

DIRECT/INDIRECT

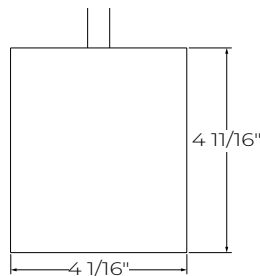

VIA 4 SEAL

PENDANT

CHROMAWERX - SOLA, DUO



SEALWERX SERIES

Environment Options

Direct				
IP66	IP65EC <small>Electrical Components</small>	IP64	IP54	IP44
Dust tight High water resistance	Dust tight Moderate water resistance	Dust tight Water splash resistance	Dust protected Water splash resistance	Particles larger than 1mm protected Water splash resistance
Directly exposed to the elements	Moderate exposure to the elements	OUTDOOR Under canopy, slightly exposed		Under canopy, not exposed
Wipe down application Healthcare application Cleanroom application		INDOOR Wipe down application Healthcare application		
<p>external end cap gasket</p>			<p>internal end cap gasket</p>	
External joiner gasket every 12'	Continuous line of light over 12'	External joiner gasket every 12'	Internal joiner gasket with soft shadow line every 12'	Continuous line of light over 12'
Driver: in a sealed enclosure Electrical connections: water and dust proof				
LED boards: conformal coated for maximum protection				
Protective finish options: Corrosion-resistant, Natatorium and Marine				

Ambient Temperature Range based on driver selection

	LD2	SD1 / DMX / DDA / DDA8	DD1
Minimum temperature:	0 °C / 32 °F	-20 °C / -4 °F	-25 °C / -13 °F
Maximum temperature:		40 °C / 104 °F	



VIA 4 SEAL

PENDANT

CHROMAWERX - SOLA, DUO



SEALWERX SERIES

Environment Options

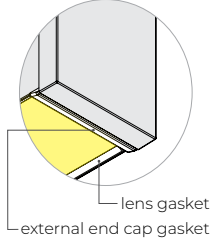
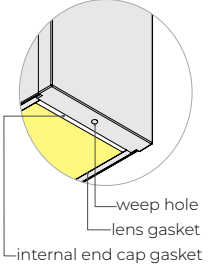
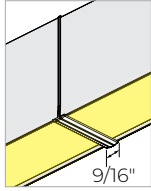
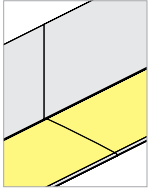
Direct/Indirect		
IP65	IP64	IP44
Dust tight Moderate water resistance	Dust tight Water splash resistance	Particles larger than 1mm protected Water splash resistance
Moderate exposure to the elements	OUTDOOR Under canopy, slightly exposed	Under canopy, not exposed
Wipe down application Healthcare application Cleanroom application	INDOOR Wipe down application Healthcare application	
		
External joiner gasket every 12' 	Continuous line of light over 12' 	
Driver: in a sealed enclosure Electrical connections: water and dust proof		
LED boards: conformal coated for maximum protection		
Protective finish options: Corrosion-resistant, Natatorium and Marine		

Ambient Temperature Range

based on driver selection

	LD2	SD1 / DMX / DDA / DDA8	DD1
Minimum temperature:	0 °C / 32 °F	-20 °C / -4 °F	-25 °C / -13 °F
Maximum temperature:		40 °C / 104 °F	

3737 Cote Vertu St-Laurent, Quebec, Canada H4R 2C9
T (514) 225-4304 F (514) 931-4862
www.Lumenwerx.com



Lumenwerx reserves the right to modify product specifications without notification.
© Lumenwerx, ULC. All rights reserved.
VIA4SEAL-PENDANT-TW-SPEC-REV6 January 13, 2026

VIA 4 SEAL

PENDANT

CHROMAWERX - SOLA, DUO



SEALWERX SERIES

Photometrics

Values calculated based on a 4' fixture at 3500K for all optics.

DIRECT

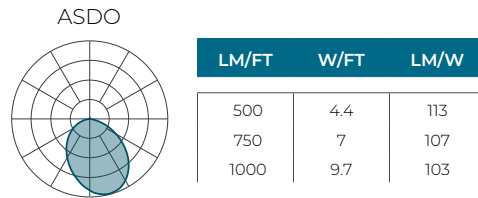
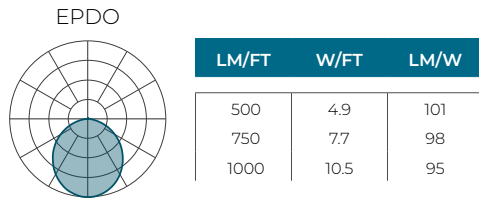

MULTIPLIERS

Use this table to get results for different color temperatures for all photometric tables.

SOLA

CCT	WATTS	LPW
	80+ CRI / 90+ CRI	80+ CRI / 90+ CRI
3500K	1.00	1.00

DUO

CCT	WATTS	LPW
	80+ CRI / 90+ CRI	80+ CRI / 90+ CRI
2700K	1.05	0.95
6500K	1.00	1.00

VIA 4 SEAL

PENDANT

CHROMAWERX - SOLA, DUO



SEALWERX SERIES

Photometrics

Values calculated based on a 4' fixture at 3500K for all optics.

DIRECT/INDIRECT

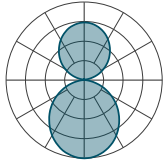

EPDO - EPIO

LM/FT		TOTAL LM/FT	W/FT	LM/W
D	I			

EPDO	EPIO			
	500	1000	10.1	99
500	750	1250	13.2	95
	1000	1500	16.3	92
750	500	1250	12.9	97
	750	1500	15.8	95
1000	1000	1750	19.0	92
	500	1500	15.8	95
1000	750	1750	18.8	93
	1000	2000	22.0	91

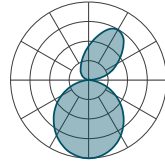

EPDO - ASIO

LM/FT		TOTAL LM/FT	W/FT	LM/W
D	I			

EPDO	ASIO			
	500	1000	9.2	109
500	750	1250	11.6	108
	1000	1500	14.2	106
750	500	1250	11.9	105
	750	1500	14.3	105
1000	1000	1750	16.8	104
	500	1500	14.9	101
1000	750	1750	17.2	102
	1000	2000	19.8	101

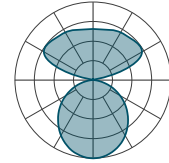

EPDO - WIO2

LM/FT		TOTAL LM/FT	W/FT	LM/W
D	I			

EPDO	WIO2			
	500	1000	9.1	110
500	750	1250	11.5	109
	1000	1500	14.0	107
750	500	1250	11.8	106
	750	1500	14.2	106
1000	1000	1750	16.7	105
	500	1500	14.7	102
1000	750	1750	17.2	102
	1000	2000	19.6	102

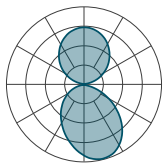

ASDO - EPIO

LM/FT		TOTAL LM/FT	W/FT	LM/W
D	I			

ASDO	EPIO			
	500	1000	9.6	104
500	750	1250	12.6	99
	1000	1500	15.8	95
750	500	1250	12.1	103
	750	1500	15.2	99
1000	1000	1750	18.4	95
	500	1500	14.9	101
1000	750	1750	17.9	98
	1000	2000	21.3	94

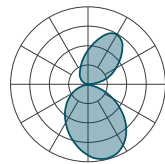

ASDO - ASIO

LM/FT		TOTAL LM/FT	W/FT	LM/W
D	I			

ASDO	ASIO			
	500	1000	8.6	116
500	750	1250	11.1	113
	1000	1500	13.6	110
750	500	1250	11.2	112
	750	1500	13.6	110
1000	1000	1750	16.2	108
	500	1500	14.0	107
1000	750	1750	16.4	107
	1000	2000	18.9	106

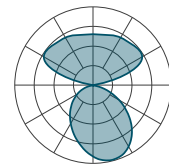

ASDO - WIO2

LM/FT		TOTAL LM/FT	W/FT	LM/W
D	I			

ASDO	WIO2			
	500	1000	8.5	117
500	750	1250	11.0	114
	1000	1500	13.5	111
750	500	1250	11.2	112
	750	1500	13.5	111
1000	1000	1750	16.1	109
	500	1500	13.9	108
1000	750	1750	16.2	108
	1000	2000	18.9	106

MULTIPLIERS

Use this table to get results for different color temperatures for all photometric tables.

SOLA

CCT	WATTS		LPW
	80+ CRI / 90+ CRI	80+ CRI / 90+ CRI	
3500K	1.00	1.00	

DUO

CCT	WATTS		LPW
	80+ CRI / 90+ CRI	80+ CRI / 90+ CRI	
2700K	1.05	0.95	
6500K	1.00	1.00	



VIA 4 SEAL

PENDANT

CHROMAWERX - SOLA, DUO



SEALWERX SERIES

Technical Specifications

DIRECT OPTICS

Environmentally Protected Direct Optic (EPDO)

The Environmentally Protected Direct Optic creates a seal that blocks debris and moisture, and withstands UV distortion and moderate impact. This extruded snap-in lens has a gasket to ensure proper sealing. The lens is 1/16" thick and made of frosted polycarbonate. Internally, white, side kicking reflectors guide the light through the lens. The EPDO suits moderate climate environments.

Asymmetric Soft Direct Optic (ASDO)

The Asymmetric Soft Direct Optic creates a seal that blocks debris and moisture, and withstands UV distortion and moderate impact. This extruded snap-in lens has a gasket to ensure proper sealing. The lens is 1/16" thick and made of frosted polycarbonate. Internally, white, side kicking reflectors specifically angled to guide the light through the lens to create a nice asymmetric distribution. The ASDO suits moderate climate environments.

INDIRECT OPTICS

Environmentally Protected Indirect Optic (EPIO)

The Environmentally Protected Indirect Optic creates a seal that blocks debris and moisture, and withstands UV distortion and moderate impact. The lens is 1/16" thick and made of frosted polycarbonate. This extruded snap-in lens has a gasket to ensure proper sealing. The EPIO suits moderate climate environments.

Asymmetric Soft Indirect Optic (ASIO)

The Asymmetric Soft Indirect Optic creates a seal that blocks debris and moisture, and withstands UV distortion and moderate impact. The lens is 1/16" thick and made of clear polycarbonate. This extruded snap-in lens has a gasket to ensure proper sealing. The total internal reflection and surface scattering optic is specifically angled to guide the light through the lens to create a nice asymmetric distribution. The ASIO suits moderate climate environments.

Widespread Indirect Optic (WIO2)

The Widespread Indirect Optic creates a seal that blocks debris and moisture, and withstands UV distortion and moderate impact. The lens is 1/16" thick and made of clear polycarbonate. This extruded snap-in lens has a gasket to ensure proper sealing. The total internal reflection and surface scattering optic offers an impressive 160° spread. WIO2 creates an even illumination for smooth brightness on the ceiling that can achieve uniformity ratios of up to 2:1. The WIO2 suits moderate climate environments.

Uniformity [max/min]

Based on 18' continuous runs, in a 20' x 40' room, 10' wall height

Mounting height from ceiling	Spacing (Center to center)		
	8'	10'	12'
24"	3.0	5.5	8.0
36"	2.0	3.0	4.5
48"	2.0	2.0	3.5

LIGHT SOURCE

Custom linear array of alternating color temperature mid-flux LEDs are mounted directly to the housing for optimal thermal performance. For the DUO products, a color temperature range from 6500K-2700K is achievable with color points on or below the black body curve. For the SOLA products, a color temperature range from 3500K-2200K is controlled synchronously with intensity. Color consistency between fixtures is maintained to within 3 SDCM. All LEDs have been tested in accordance with IESNA LM-80-08 and the results have shown L80 lumen maintenance greater than 60,000 hours. Absolute product photometry is measured and presented in accordance with IESNA LM-79, unless otherwise indicated.

Chromawerx SOLA

It is a single-channel control that dims output while warming the color temperature in a pre-determined relationship. A simple analog control sends a common signal to dual output digital drivers, which are programmed to adjust a specially populated LED array to emulate the effect of dimming a filament source. Dimming range is programmable but the default option runs from 3500K at 100% of full power to 2200K at 5% of full power. CRI is maintained above 80 throughout the dimming range.

VIA 4 SEAL

PENDANT

CHROMAWERX - SOLA, DUO



SEALWERX SERIES

Chromawerx DUO

It is a two-channel control. It uses an analog (0-10V) protocol for separate control of luminaire CCT and intensity or a digital (DMX, DALI, and LD2) protocol for synchronous control of both warm and cool LED arrays to enable the user to set color temperature and light output. Commonly called "tunable white", Chromawerx two-channel control provides the range of cool (6500K) to warm (2700K) color that can be useful for helping to entrain circadian rhythms, stimulate alertness for improved educational and work productivity, and compensate for jet lag, among other applications. The Chromawerx drivers are programmed to limit maximum light output and power usage across all color temperatures. CRI is maintained above 80. When paired with DALI drivers (DDA/DDA8), color tuning follows a linear dimming curve.

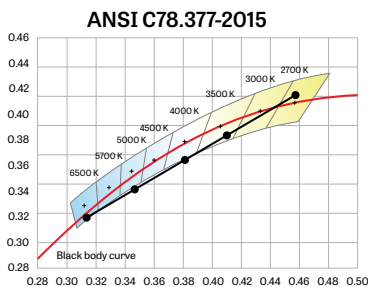

WELL BUILDING STANDARD



WELL for Light: The WELL building standard focuses on light quality in several features. There are three categories that are fully attributed to the construction and features of a luminaire. In WELL V1, it's Feature 54 Circadian Lighting, Feature 55 Glare Control, and Feature 58 Color Quality. In WELL V2, it's Feature L03 Circadian Lighting, Feature L04 Glare Control, and Feature L07 Electric Light Quality.

This fixture meets Features:

- Feature 54 or L03 when DUO is selected
- Feature 55 or L04 meets WELL glare category (c-d) (not applicable with 1000 lm/ft)
- Feature 58 or L07 when 90+ CRI is selected

All LED drivers used at Lumenwerx are deemed to have a low risk level of flicker, of 5% or less below 90Hz operational as defined by IEEE standard 1789-2015 LED.



WELL for Mind: This luminaire meets WELL for mind as it is a human centric luminaire offering quality light, excellent color, and smooth optics. If any of these features are incorporated in a luminaire, it can improve the ability to focus, concentrate, and persist longer on a given task. This fixture harmoniously operates in a space to assist the mind.

For more information, please contact well@lumenwerx.com

LUMINAIRE LENGTH

Via 4 Seal is available in standard lengths of 2' to 12'. Continuous runs are available for run lengths over 12'. Exact run length must be noted in the product code. The minimum length is 2' for Direct fixtures, and 3' for Direct/Indirect fixtures. Lengths can be ordered in 1' and/or 1" increments. All individual sections are joined together onsite using the joiner kits provided. Lumenwerx joiner kits are extremely simple to work with in the field and result in a fixture that appears virtually seamless with no light leak at any connection.

WEEP HOLES

The Direct/Indirect fixtures, with the IP44-Rated option, feature a weep hole situated in the end cap. Water and moisture that enters the fixture will be expelled through this hole.



TEMPERATURE VARIATION PROTECTION

Fixtures with the IP66-Rated, IP65-Rated, IP65-Rated Electrical Components and IP64-Rated environment options feature an integrated pressure equalization and moisture control GORE® protective vent. It allows air to flow while blocking water, dust, and contaminants. It also reduces internal condensation, supports thermal stability, and preserves the fixture's sealed performance over time.



Location may vary.

VIA 4 SEAL

PENDANT

CHROMAWERX - SOLA, DUO



SEALWERX SERIES

ELECTRICAL

SOLA

SD1

Factory-set, adjustable output current LED driver with universal (120-277 VAC) input. Using a single 0-10V control signal, the light output warms in color temperature as it dims down to 1% and 2200K. At maximum driver load, efficiency<86%, PF>0.9, THD<20%.

DUO

DMX

Factory-set adjustable output current electronic driver with 120-277 VAC line input. Using DMX wall controls (optionally supplied by Lumenwerx) or an existing DMX control system, both channels of LEDs are independently adjustable. Each DMX driver can be independently addressed using the built-in RDM (Remote Device Management) in the field. Dimming down to 1% is attainable. Rated life (90% survivorship) of 50,000 hours at 50°C maximum ambient temperature. At maximum driver load, efficiency<84%, PF>0.9, THD<20%.

DALI

Factory-set adjustable output current electronic driver with 120-277 VAC line input. Using an existing DALI control system (supplied by others), one control channel adjusts the fixture color temperature, and the other control channel adjusts fixture brightness. With DALI Type 6, two DALI addresses are required to control both channels. With DALI Type 8, one DALI address is required to control both channels. Dimming down to 1% is attainable. Rated life (90% survivorship) of 50,000 hours at 50°C maximum ambient temperature. At maximum driver load, efficiency<84%, PF>0.9, THD<20%.

DD1

Factory-set adjustable output current LED driver with universal (120-277 VAC) input. Controlled via two individual 0-10V signals, one for setting light output down to a minimum of 1% and the other for adjusting the CCT (default range of 6500K-2700K). Rated life of 50,000 hours at 70°C maximum driver case temperature and 100% load conditions. Typical efficiency of 86%, PF>0.9, THD<20% at 100% load conditions.

LD2

Lutron DALI-2 digital drivers provide a high-performance tunable white solution with single-address digital control. Guaranteed performance and compatibility when used with Lutron DALI-2 controls.

PoE

Depending on the PoE manufacturer selected, Lumenwerx will install the node in factory as either integral to the luminaire or as a remote module. Factory programming of the PoE node may or may not enable the following functionalities: lumen package, DUO (tunable white), QUADRO (RGBW), emergency battery backup, and sensor integration. These must be addressed and evaluated on a case-by-case basis.

MOUNTING

Pendant fixtures can be mounted with stem. See page 3 for details. Additional bracing by others required for wind and earthquake exposure.

FINISH

Interior: 95%, reflective matte powder coated white paint

Exterior: Powder-coat paint in matte white, matte black, or aluminum. Custom finishes are also available. Optional antimicrobial finish.

FINISH OPTIONS

Corrosion-resistant: General protection from moisture, humidity, cleaners, and mild chemicals

Natatorium: Protection from chlorine vapour, high humidity, and condensation

Marine: Protection from salt spray, air, and UV

CONSTRUCTION

Housing: Extruded aluminum, up to 90% recycled content

Interior brackets: Die-formed cold rolled sheet steel

Gaskets: Closed-cell silicone foam

Reflectors: Die-formed cold rolled sheet steel, 95% reflective matte white painted

End cap: Die-cast aluminum

WEIGHT

Direct	Direct/Indirect
4': 15.0 lbs - 6.8 kg	4': 17.2 lbs - 7.8 kg
8': 27.6 lbs - 12.5 kg	8': 32.8 lbs - 14.9 kg
12': 40.1 lbs - 18.2 kg	12': 48.5 lbs - 22 kg

CERTIFICATIONS

ETL: IP44-Rated environment option is rated for dry/damp locations. IP66-Rated, IP65-Rated, IP65-Rated Electrical Components, IP64-Rated and IP54-Rated environment options are ETL Wet Listed. Conforms to UL Standard 1598 and certified to CAN/CSA Standard C22.2 No. 250.0. During the installation of Wet Listed fixtures, the contractor is responsible for properly sealing all mounting and electrical connection points.

IK08: Impact resistance rated to IK08



VIA 4 SEAL

PENDANT

CHROMAWERX - SOLA, DUO



SEALWERX SERIES

WARRANTY

Lumenwerx provides a five-year limited warranty on electrical and mechanical performance of the luminaires, including the LED boards, drivers, and auxiliary electronics. Lumenwerx will repair or replace defective luminaires or components at our discretion, provided they have been installed and operated in accordance with our specifications. Other limitations apply, please refer to the full warranty on our website.

Wall controllers are covered by the manufacturer warranty.

VIA 4 SEAL

PENDANT

CHROMAWERX - SOLA, DUO



SEALWERX SERIES

DUO DMX SPECIFICATION

A qualified DMX integrator is required to assure proper installation and commissioning of the DMX network. **When placing the PO, please provide the contact information of your DMX integrator.**

Please answer the following questions to help us identify your DMX network requirements.

YES

Do you require a wall controller provided by Lumenwerx?

NO

DMX controller supplied by Lumenwerx

DMX control system supplied by others. Lumenwerx will supply DMX-enabled fixtures with default DMX addressing. See following pages for technical DMX informations. ✓

How many zones do you have?

A zone consists of one or more luminaires behaving identically.

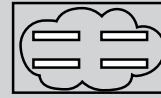

1 Zone



2 Zones

How to calculate the required number of drivers:

per 4' fixture

Driver
1x driver

Direct only

per 4' fixture

Driver Driver
2x driver

Direct high output

To Calculate # of drivers

1 - 4 Zones

5 or more Zones

Do you have more than 32 drivers in total?

NO

YES

Order a standard Lumenwerx wall controller.

WALL CONTROLLER

WCW - wall controller white
WCB - wall controller black

Add the control code at the end of your order code.

Please provide a fixture layout or RCP (Reflected Ceiling Plan) showing the locations of the DMX fixtures, zones and the DMX wall controller.

Refer to your DMX integrator for the installation. ✓

Subject to factory evaluation. Please contact our controls specialist at controls@lumenwerx.com. Additional cost and equipment will be required. ✓

Subject to factory evaluation and approval. Please contact our controls specialist at controls@lumenwerx.com. Additional cost and equipment will be required. ✓

VIA 4 SEAL

PENDANT

CHROMAWERX - SOLA, DUO

SEALWERX SERIES



GENERIC DMX NETWORK ARCHITECTURE

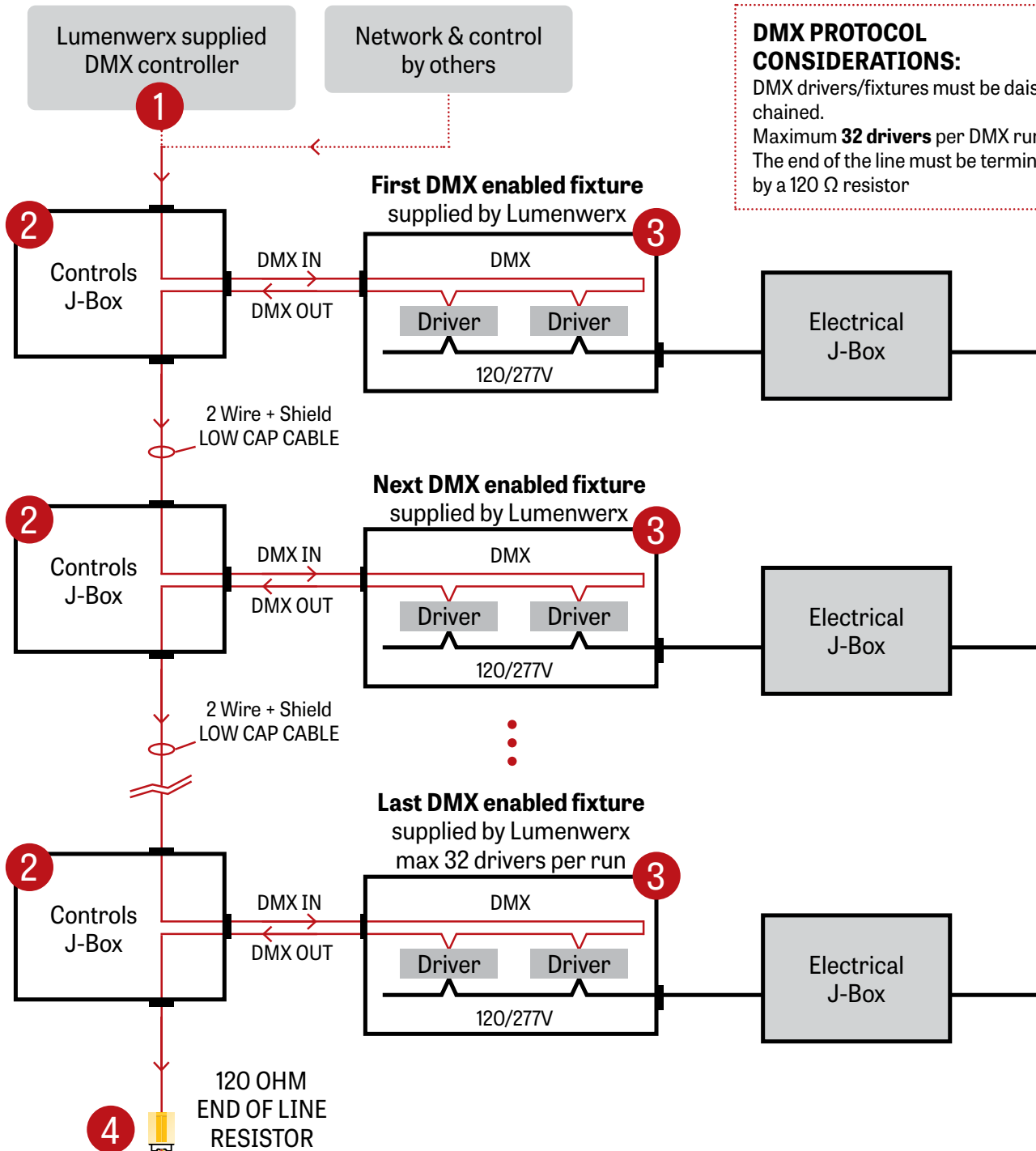

DMX PROTOCOL CONSIDERATIONS:

DMX drivers/fixtures must be daisy chained.
Maximum **32 drivers** per DMX run.
The end of the line must be terminated by a 120 Ω resistor

VIA 4 SEAL

PENDANT

CHROMAWERX - SOLA, DUO



SEALWERX SERIES

1 LUMENWERX SUPPLIED DMX CONTROLLER

To the first fixture

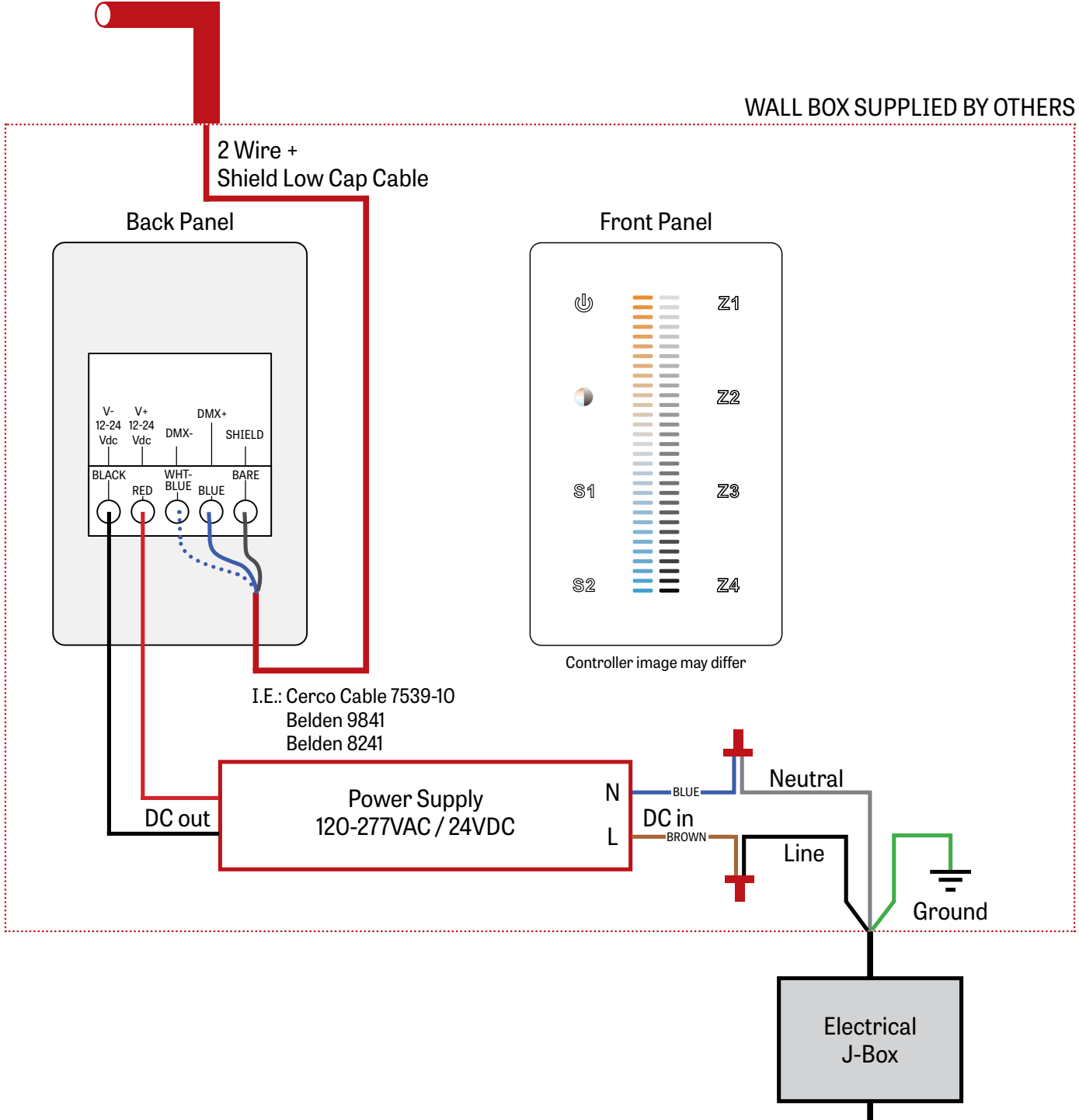

VIA 4 SEAL

PENDANT

CHROMAWERX - SOLA, DUO

SEALWERX SERIES



2 J-BOX DMX DAISY CHAIN DETAIL

Low capacitance DMX Cable from Previous Fixture

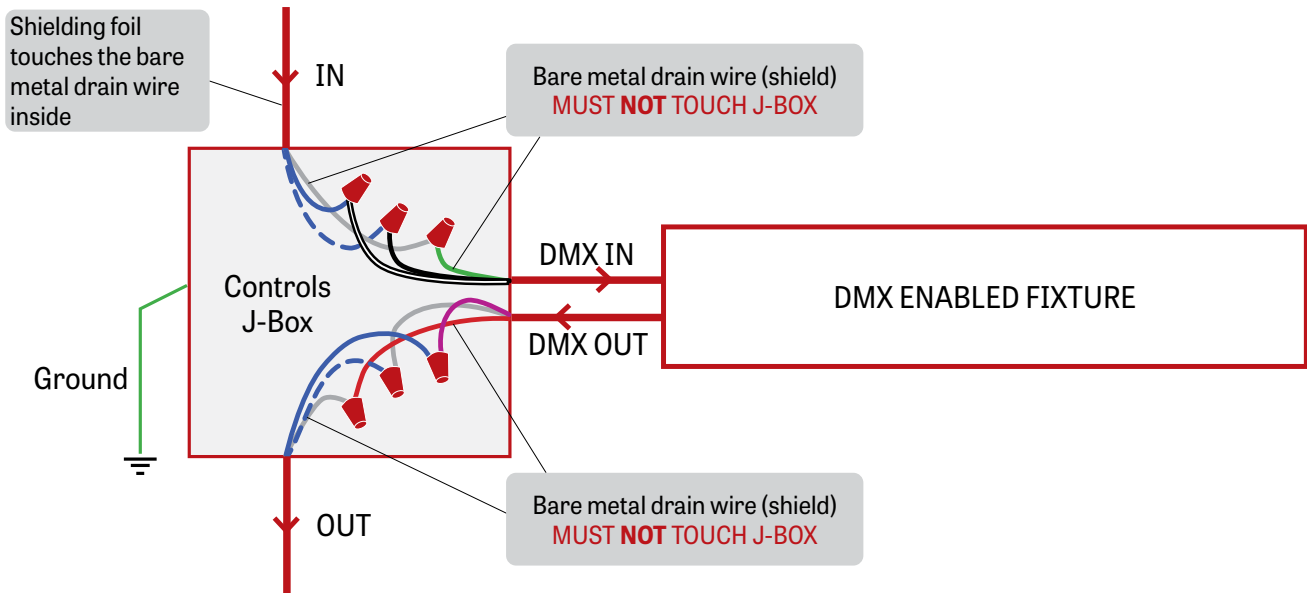

Low capacitance DMX cable to next fixture

3 DMX CONNECTION PENDANT & WALL

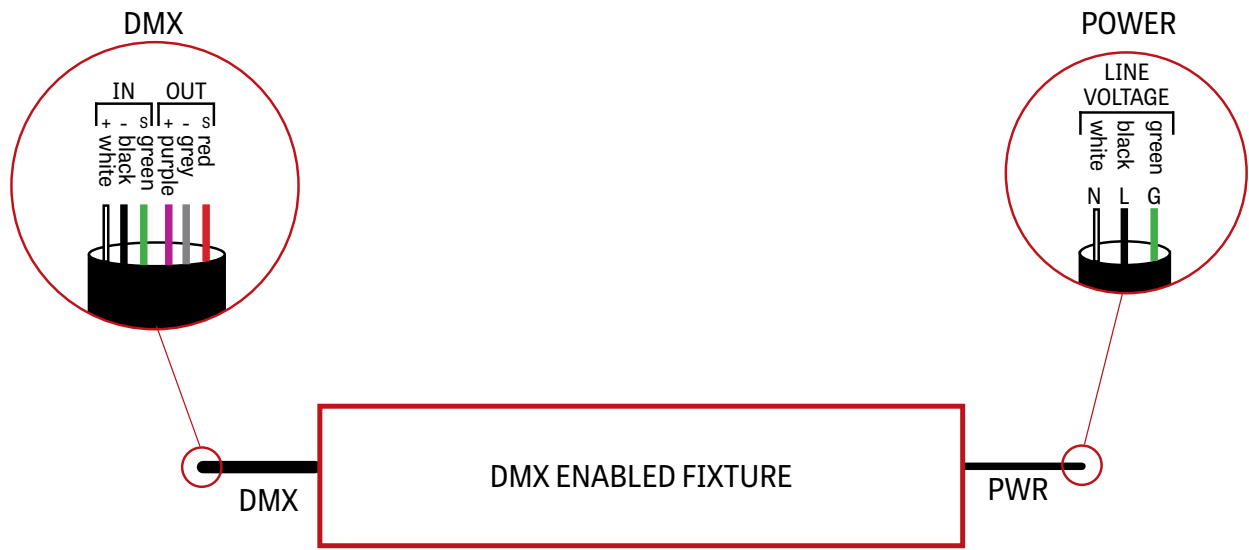

VIA 4 SEAL

PENDANT

CHROMAWERX - SOLA, DUO

SEALWERX SERIES



4 DMX LAST FIXTURE DETAIL

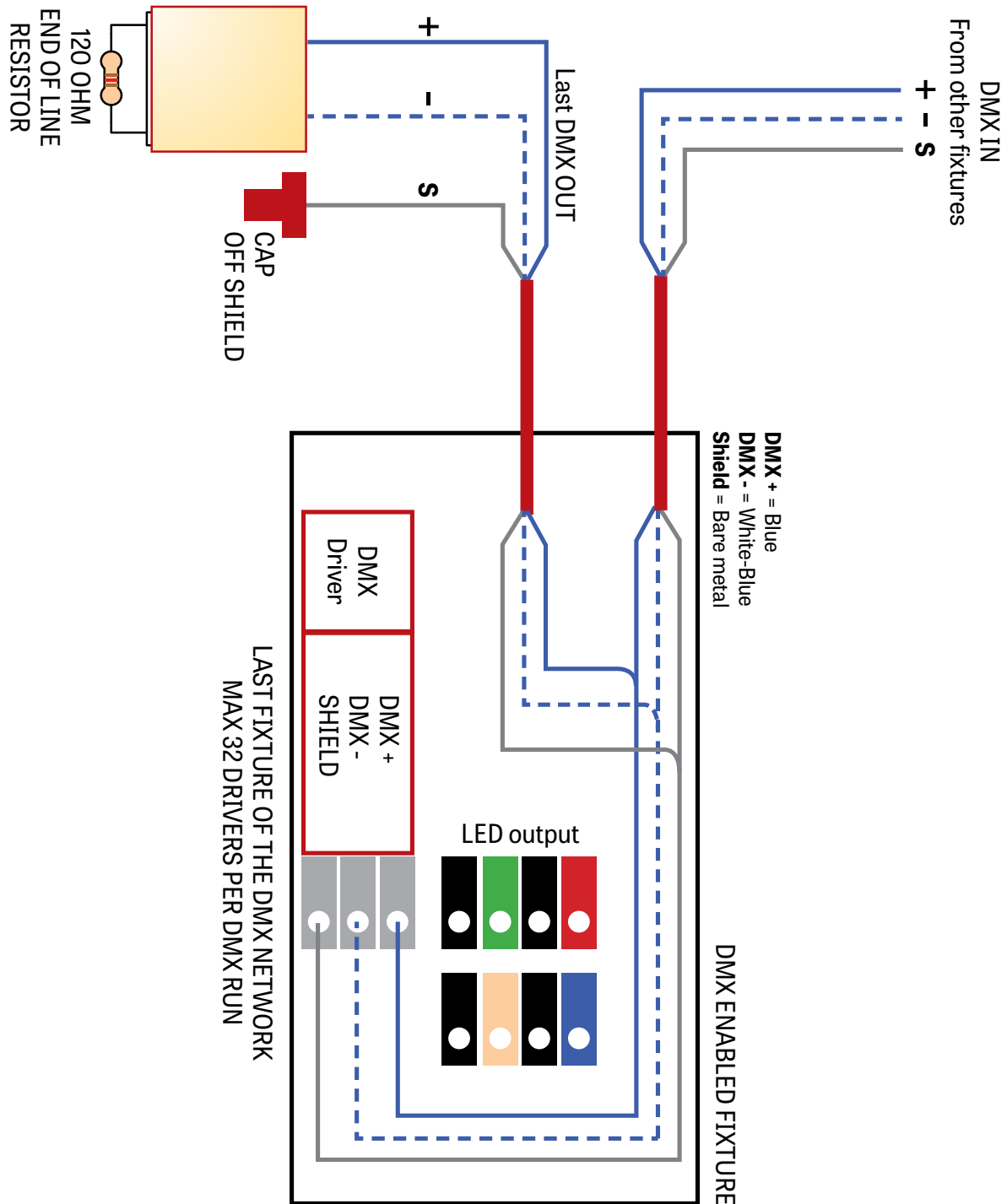

VIA 4 SEAL

PENDANT

CHROMAWERX - SOLA, DUO



SEALWERX SERIES

DMX WALL CONTROLLER

DUO 1-4 ZONE

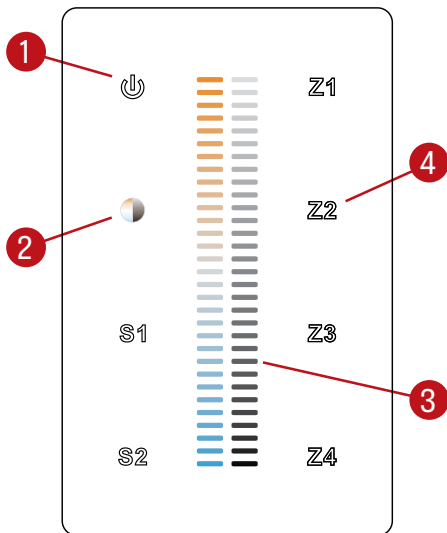

- (1) Power: Use this button to turn ON or OFF the fixture.
- (2) Brightness/CCT: Use the color/brightness toggle button to choose between color/brightness. When Blue: brightness is selected, when Yellow: color is selected.
- (3) Slider: Depending on the mode chosen in step 2, the slider will allow the user to set desired color or brightness.
- (4) Zone select: Up to 4 zones can be selected either independently or together. Once selected, the commands will be sent to the zone identified by a Blue LED.

Default DMX Addresses:

- 1 Warm
- 2 Cool

VIA 4 SEAL

PENDANT

CHROMAWERX - SOLA, DUO

SEALWERX SERIES



DUAL 0-10V WALL CONTROLLER

Front Panel

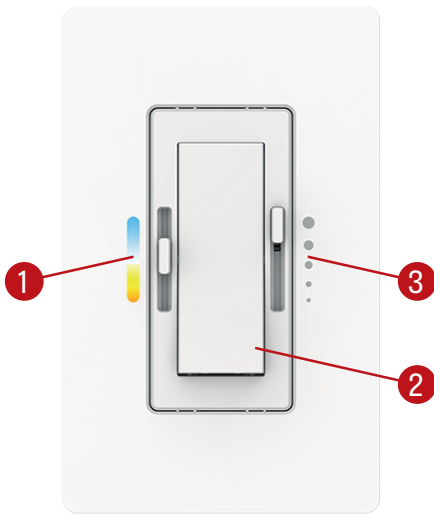

Controller image may differ

Dimensions

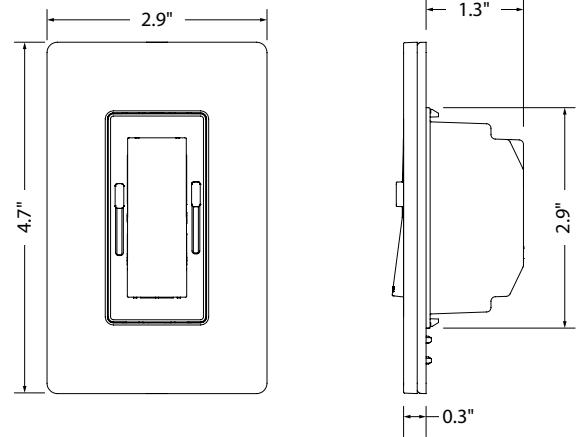

- (1) CCT control: Use this button to adjust the color temperature.
- (2) On/Off switch: Use this button to turn ON or OFF the fixture.
- (3) Dimming control: Use this button to adjust the brightness.

Wiring Diagram

