

# VIA 5 RECESSED

DIRECT  
CHROMAWERX - QUADRO - RGBW



IC RATED



**SENSORS**  
For latest information on sensors, click [here](#).

Our elegant, flexible Via family is composed of linear, pendant, surface, recessed, and wall mounted luminaires. Each lighting fixture can be installed as a discrete luminaire or in continuous runs or patterns. Via 5 Recessed is offered with Lambertian, asymmetric, or wall wash optics.



# VIA 5 RECESSED



DIRECT  
CHROMAWERX - QUADRO - RGBW

Project: \_\_\_\_\_

Type: \_\_\_\_\_

## Order Guide

| LUMINAIRE ID                   | DISTRIBUTION      | OPTIC  | LENS POSITION   | LIGHT SOURCE <sup>2</sup>  |
|--------------------------------|-------------------|--|---|--|
| <b>VIA5R</b>                   | <b>D</b>          |  |   |  |
| <b>VIA5R</b> - Via 5" Recessed | <b>D</b> - Direct | <b>HLO</b> - High-Efficiency Lambertian Optic<br><b>ARO2</b> - Asymmetric Refractive Optic<br><b>WRO2</b> - Wall Wash Refractive Optic | <b>FH</b> <sup>1</sup> - Flush<br><b>RG</b> <sup>1</sup> - Regressed<br><b>1.0D</b> <sup>1</sup> - 1.0" drop<br><br><sup>1</sup> For HLO, specify FH, RG, or 1.0D.<br><sup>1</sup> For ARO2 and WRO2, specify FH. | <b>QUADRO</b> - RGBW 4-channel control<br><b>RS</b> - Red solid<br><b>GS</b> - Green solid<br><b>BS</b> - Blue solid<br><br><sup>2</sup> Static white, BIOS, Chromawerx SOLA, and DUO also available. Consult other spec sheets. |

| WHITE CRI<br>Specify NA for solid colors                                       | WHITE COLOR TEMP.<br>Specify NA for solid colors   | OUTPUT WATTAGE <sup>3</sup>   | LUMINAIRE LENGTH   | VOLTAGE  |
|--|--|---|--|--|
| <b>80CRI</b> - 80+ CRI<br><b>90CRI</b> - 90+ CRI<br><b>NA</b> - Not applicable | <b>27K</b> - 2700K<br><b>30K</b> - 3000K<br><b>35K</b> - 3500K<br><b>40K</b> - 4000K<br><b>50K</b> - 5000K<br><b>NA</b> - Not applicable | HLO<br><b>8WF</b> - 8 W/ft output<br><b>10WF</b> <sup>4</sup> - 10 W/ft output<br><b>12WF</b> <sup>4</sup> - 12 W/ft output<br><br>ARO2<br>WRO2<br><b>5WF</b> - 5 W/ft output<br><b>7WF</b> <sup>4</sup> - 7 W/ft output<br><br><sup>3</sup> See page 3 for dedicated white channel lumen outputs.<br><sup>4</sup> Not available with solid colors. | <b>#FT#IN</b> <sup>5</sup> - Specify nominal length (#) in 1' and/or 6" increments<br><br><b>Standard nominal lengths:</b><br>Single units: 4' to 12'<br>Continuous runs: lengths over 12'<br><br><sup>5</sup> Minimum length is 4'. | <b>120V</b> - 120V<br><b>277V</b> - 277V<br><b>UNV</b> - 120V-277V |

| DRIVER <sup>6</sup>   | ELECTRICAL                             | MOUNTING <sup>9</sup>   | FINISH   | OPTIONS <sup>11</sup>   |
|---|--|---|--|---|
| <b>QUADRO</b><br><b>DMX</b> <sup>7,8</sup> - DMX<br><br><u>Solid colors</u><br><b>DI</b> - 1% 0-10V<br><b>DA</b> <sup>8</sup> - DALI<br><br><sup>6</sup> PoE (Power-over-Ethernet) compatible. Consult factory for details.<br><sup>7</sup> For more information, see pages 7 to 12.<br><sup>8</sup> On-site commissioning is required. | <b>1C</b><br><br><b>1C</b> - 1 circuit | <b>TG9</b> - Tegular 9/16"<br><b>TG15</b> - Tegular 15/16"<br><b>TB9</b> - T-bar 9/16"<br><b>TB15</b> - T-bar 15/16"<br><b>ST</b> - Screw slot T-bar<br><b>DTR</b> - Trim<br><b>DTL</b> - Trimless<br><b>DMF</b> - Drywall mud flange<br><br><b>MFM</b> <sup>10</sup> - Multiple flange mounting<br><br><sup>9</sup> Transition mounting options also available (e.g. Recessed to Pendant/Surface), consult factory for details.<br><sup>10</sup> See page 4 for details. | <b>W</b> - Matte white<br><b>B</b> - Matte black<br><b>CF#</b> - Custom finish, specify RAL# | <b>FU120</b> - Fuse 120V<br><b>FU277</b> - Fuse 277V<br><b>FWC</b> - Flexible whip cable (6' std)<br><b>CP</b> - Chicago Plenum<br><b>NA</b> - None<br><br><sup>11</sup> Separate codes with a "+" if more than one is specified. |

## Accessories

Optional, order separately

|   |
|---|
| <b>DMX WALL CONTROLLER</b> <sup>12,13</sup> |
|---|

|  |
|--|
| <b>WC1W##FT</b> - Single zone wall controller white<br><b>WC1B##FT</b> - Single zone wall controller black<br><b>WC2W##FT</b> - 3 zone wall controller white<br><b>WC2B##FT</b> - 3 zone wall controller black<br><br><sup>12</sup> Specify wire length (##) in feet.<br><sup>13</sup> Available with DMX only. For more information, see pages 7 to 12, or consult factory. |
|--|

TECHZONE™ & USG Compatible with 6" ceiling

3737 Cote Vertu St-Laurent, Quebec, Canada H4R 2C9  
T (514) 225-4304 F (514) 931-4862  
www.lumenwerx.com



Lumenwerx reserves the right to modify product specifications without notification.  
© Lumenwerx, ULC. All rights reserved.  
VIA5-RGBW-RECESSED-SPEC-REV2



# VIA 5 RECESSED



DIRECT

CHROMAWERX - QUADRO - RGBW

## Dimensions

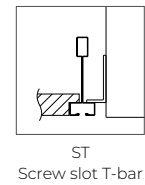
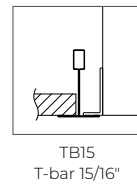
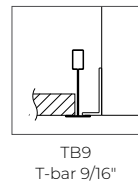
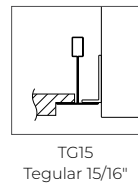
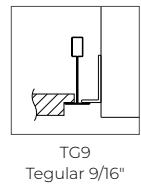
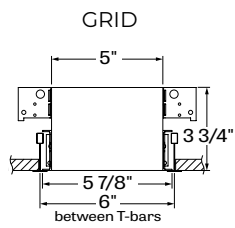
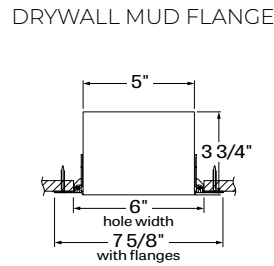
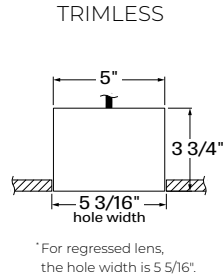
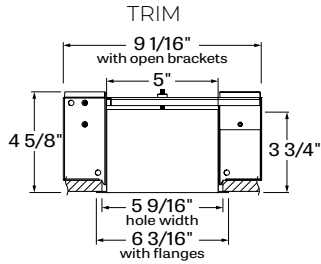

## LENS POSITIONS

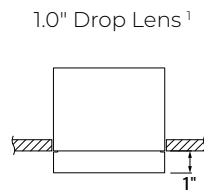
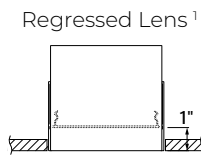

<sup>1</sup>Regressed lens and drop lens positions available with HLO only.

## Photometrics

Dedicated white channel lumen outputs are calculated with only white light on, and based on a 4' fixture at 3500K for all optics.

| OPTIC    | W/FT | LM/FT |
|----------|------|-------|
| HLO-FH   | 8    | 375   |
|          | 10   | 475   |
|          | 12   | 575   |
| HLO-RG   | 8    | 300   |
|          | 10   | 375   |
|          | 12   | 450   |
| HLO-1.0D | 8    | 350   |
|          | 10   | 450   |
|          | 12   | 525   |

| OPTIC | W/FT | LM/FT |
|-------|------|-------|
| ARO2  | 5    | 425   |
|       | 7    | 600   |
| WRO2  | 5    | 425   |
|       | 7    | 600   |

# VIA 5 RECESSED



DIRECT

CHROMAWERX - QUADRO - RGBW

## Multiple Flange Mounting Details

Multiple flange mounting can be specified when a fixture run needs to have a multiple flange recessed mounting detail. A drawing is required to clearly illustrate the application.

CEILING CONDITION EXAMPLES (consult factory for project specific ceiling conditions)

**DRYWALL/GRID**

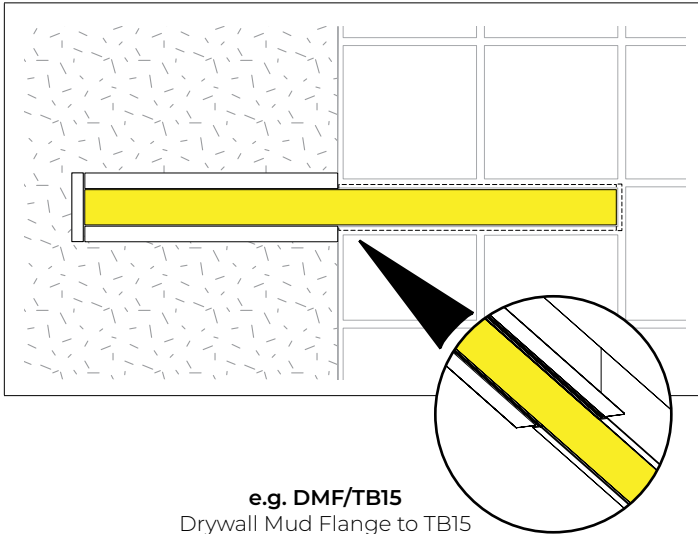

**e.g. DMF/TB15**  
Drywall Mud Flange to TB15

**DRYWALL/WOOD**

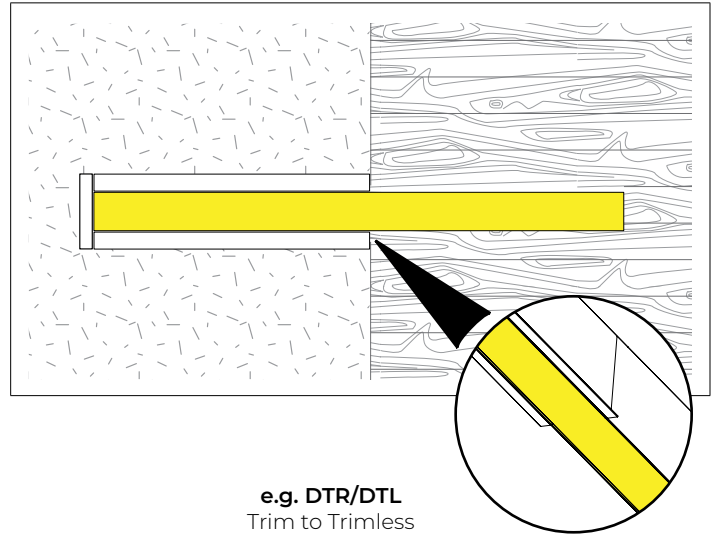

**e.g. DTR/DTL**  
Trim to Trimless

**DRYWALL/GRID**

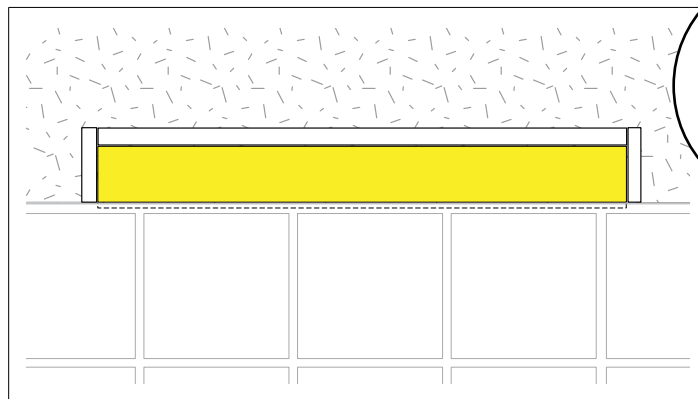

**e.g. 1TG9/3DTR**  
1 long side TG9 and other  
3 sides DTR

All drawings are for illustrative purposes only.

## TRANSITION MOUNTING OPTIONS (consult factory for details)

Mounting condition alters along the run of the fixture.

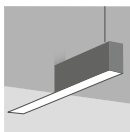

Recessed to Pendant

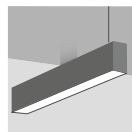

Surface to Pendant

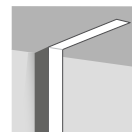

Surface to Recessed in corner

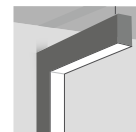

Surface to Pendant in corner

# VIA 5 RECESSED

DIRECT

CHROMAWERX - QUADRO - RGBW



## Technical Specifications

### OPTICS

#### High-Efficiency Lambertian Optic (HLO)

The High-Efficiency Lambertian Optic (HLO) uses matte white reflectors to distribute LED output across 0.075" acrylic shielding, providing up to 88% transmission and good obscuration.

Available as a flush lens or as a drop lens, the HLO has a spacing criterion of 1.22.

#### Asymmetric Refractive Optic (ARO2)

The Asymmetric Refractive Optic (ARO2) uses a sophisticated reflector combined with a matte beam-shaping film to create a smooth, effective downward light component without shadows or hot spots. It provides directional Gaussian light distribution with peak intensity at 20° above nadir and a 55° Full Width at Half Maximum (FWHM) beam angle. Microstructure material applied to the snap-in lens provides the precise refractive power and visual comfort, while achieving a high luminous efficacy.

#### Wall Wash Refractive Optic (WRO2)

The Wall Wash Refractive Optic (WRO2) delivers smooth vertical illumination with a gentle gradient and soft visual cut-off. Its exacting configuration creates a strong downward light component without shadows or hot spots and provides light distribution with peak intensity at 21° above nadir. Microstructure material applied to the snap-in lens provides the precise refractive power and visual comfort, while achieving a high luminous efficacy.

### LIGHT SOURCE

Custom linear array of mid-flux LEDs, comprised of an alternation of an RGB and a dedicated white LED. The white LED is used for when a static white CCT is required in the space. RGB LEDs are tightly binned for excellent color control between fixtures. The white LEDs have been tested in accordance with IESNA LM-80-08 and the results have shown L80 lumen maintenance greater than 60,000 hours. Absolute product photometry is measured and presented in accordance with IESNA LM-79, unless otherwise indicated.

#### Chromawerx QUADRO

Chromawerx QUADRO is a four-channel control that operates an RGBW LED array and addresses the need for more expressive color in architectural applications. The DMX driver supports familiar programming tools for both dynamic multi-hued color and precise white color point control. While a typical user interface will be a DMX controller by others, Lumenwerx also offers a simple control station for stand-alone color changing applications.

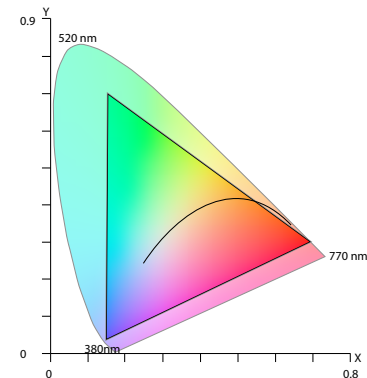

The above diagram overlays the full gamut of colors attainable with the RGBW on top of the CIE 1931 color space. Any color point inside of the triangle can be obtained by setting the correct output levels for each of the individual red, green, blue, and white channels.

### LUMINAIRE LENGTH

Via 5 is available in standard lengths of 4' to 12'. Continuous runs are available for run lengths over 12'. Exact run length must be noted in the product code. The minimum length is 4', and can be ordered in 1' and/or 6" increments. All individual sections are joined together onsite using the joiner kits provided. Lumenwerx offers joiner kits that are extremely simple to work with in the field and result in a fixture that appears virtually seamless with no light leak at any connection.

### ELECTRICAL

#### DMX

Factory-set, adjustable output current, multi-channel LED driver with universal (120-277 VAC) input. Using DMX wall controls (optionally supplied by Lumenwerx) or an existing DMX control system, four channels of LEDs (Red/Green/Blue/White) are independently adjustable. Each DMX driver has multiple output channels that can be independently addressed at the factory or on-site using built-in RDM (Remote Device Management) functionality. Dimming range from 100%-0%. At maximum driver load, efficiency < 89%, PF > 0.9, THD < 20%.

#### PoE

Depending on the PoE manufacturer selected, Lumenwerx will install the node in factory as either integral to the luminaire or as a remote module. Factory programming of the PoE node may or may not enable the following functionalities: lumen package, DUO (tunable white), QUADRO (RGBW), emergency battery backup, and sensor integration. These must be addressed and evaluated on a case-by-case basis.

# VIA 5 RECESSED



DIRECT

CHROMAWERX - QUADRO - RGBW

## MOUNTING

Recessed fixtures can be mounted into exposed or concealed T-bar or tegular ceiling, as well as in ceilings with trim, trimless, or mud flange options.

## FINISH

**Interior:** 95%, reflective matte powder coated white paint

**Exterior:** Matte white or matte black powder coating. Custom finishes are also available.

## CONSTRUCTION

**Housing:** Extruded aluminum, up to 90% recycled content

**Interior brackets:** Die-formed cold rolled sheet steel

**Joining system:** Die-cast zinc

**Reflectors:** Die-formed cold rolled steel, 95% reflective matte white painted

**Lens:** Acrylic

**Drop lens:** Extruded with glued end caps

**Recessed flanges:** Extruded aluminum, up to 90% recycled content

**Mud flange:** Extruded aluminum, up to 90% recycled content

**Slip-through bracket:** Die-formed galvanized sheet

**End plate:** Die-formed cold rolled sheet steel

## WEIGHT

**4':** 11.78 lbs - 5.35 kg

**8':** 23.79 lbs - 10.8 kg

**12':** 35.24 lbs - 16 kg

## CERTIFICATIONS

**ETL:** Rated for indoor dry/damp locations. Conforms to UL Standard 1598 and certified to CAN/CSA Standard C22.2 No. 250.0.

**Chicago Plenum:** City of Chicago Approved (CCEA) when specified with CP option.

**IC rated:** Suitable for direct contact with insulation

## WARRANTY

Lumenwerx provides a five-year limited warranty on electrical and mechanical performance of the luminaires, including the LED boards, drivers, and auxiliary electronics. Lumenwerx will repair or replace defective luminaires or components at our discretion, provided they have been installed and operated in accordance with our specifications. Other limitations apply, please refer to the full warranty on our website.

Wall controllers are covered by the manufacturer warranty.

# VIA 5 RECESSED



DIRECT

CHROMAWERX - QUADRO - RGBW

## QUADRO DMX SPECIFICATION

A qualified DMX integrator is required to assure proper installation and commissioning of the DMX network. **When placing the PO, please provide the contact information of your DMX integrator.**

Please answer the following questions to help us identify your DMX network requirements.

YES

Do you require a wall controller provided by Lumenwerx?

NO

DMX controller supplied by Lumenwerx

DMX control system supplied by others. Lumenwerx will supply DMX-enabled fixtures with default DMX addressing. See following pages for technical DMX informations. ✓

**How many zones do you have?**

A zone consists of one or more luminaires behaving identically.



1 Zone



2 Zones

**How to calculate the required number of drivers:**

per 4' fixture  
**Driver**  
1x driver  
Less than 12.5W/ft, direct only

per 4' fixture  
**Driver Driver**  
2x driver  
Above 12.5W/ft or for all direct/indirect fixture

To Calculate # of drivers

1 Zone

2 to 3 Zones

4 or more Zones

Do you have more than 32 drivers in total?

NO

YES

Order a standard Lumenwerx wall controller type 1.

### WALL CONTROLLER

**WC1W** - Single zone wall controller white  
**WC1B** - Single zone wall controller black

Add the control code at the end of your order code.

Please provide a fixture layout or RCP (Reflected Ceiling Plan) showing the locations of the DMX fixtures, zones and the DMX wall controller.

Refer to your DMX integrator for the installation. ✓

Subject to factory evaluation. Please contact our controls specialist at [controls@lumenwerx.com](mailto:controls@lumenwerx.com). Additional cost and equipment will be required. ✓

NO

YES

Order a standard Lumenwerx wall controller type 2.

### WALL CONTROLLER

**WC2W** - 3 zone wall controller white  
**WC2B** - 3 zone wall controller black

Add the control code at the end of your order code.

Please provide a fixture layout or RCP (Reflected Ceiling Plan) showing the locations of the DMX fixtures, zones and the DMX wall controller.

Refer to your DMX integrator for the installation. ✓

Subject to factory evaluation. Please contact our controls specialist at [controls@lumenwerx.com](mailto:controls@lumenwerx.com). Additional cost and equipment will be required. ✓

Subject to factory evaluation and approval. Please contact our controls specialist at [controls@lumenwerx.com](mailto:controls@lumenwerx.com). Additional cost and equipment will be required. ✓

# VIA 5 RECESSED



DIRECT  
CHROMAWERX - QUADRO - RGBW

## GENERIC DMX NETWORK ARCHITECTURE

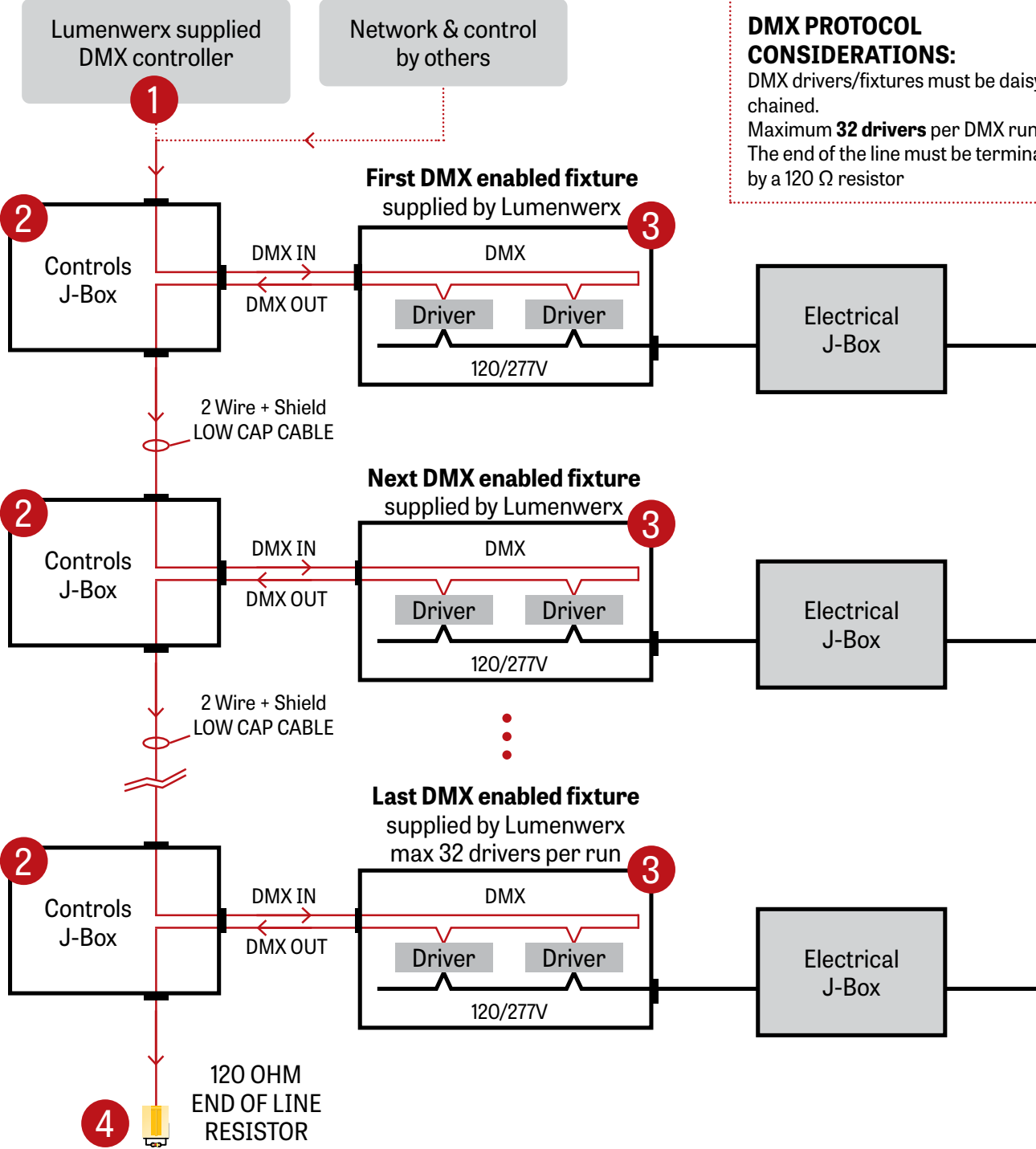

**DMX PROTOCOL CONSIDERATIONS:**  
DMX drivers/fixtures must be daisy chained.  
Maximum **32 drivers** per DMX run.  
The end of the line must be terminated by a 120 Ω resistor

# VIA 5 RECESSED



DIRECT  
CHROMAWERX - QUADRO - RGBW

## 1 LUMENWERX SUPPLIED DMX CONTROLLER

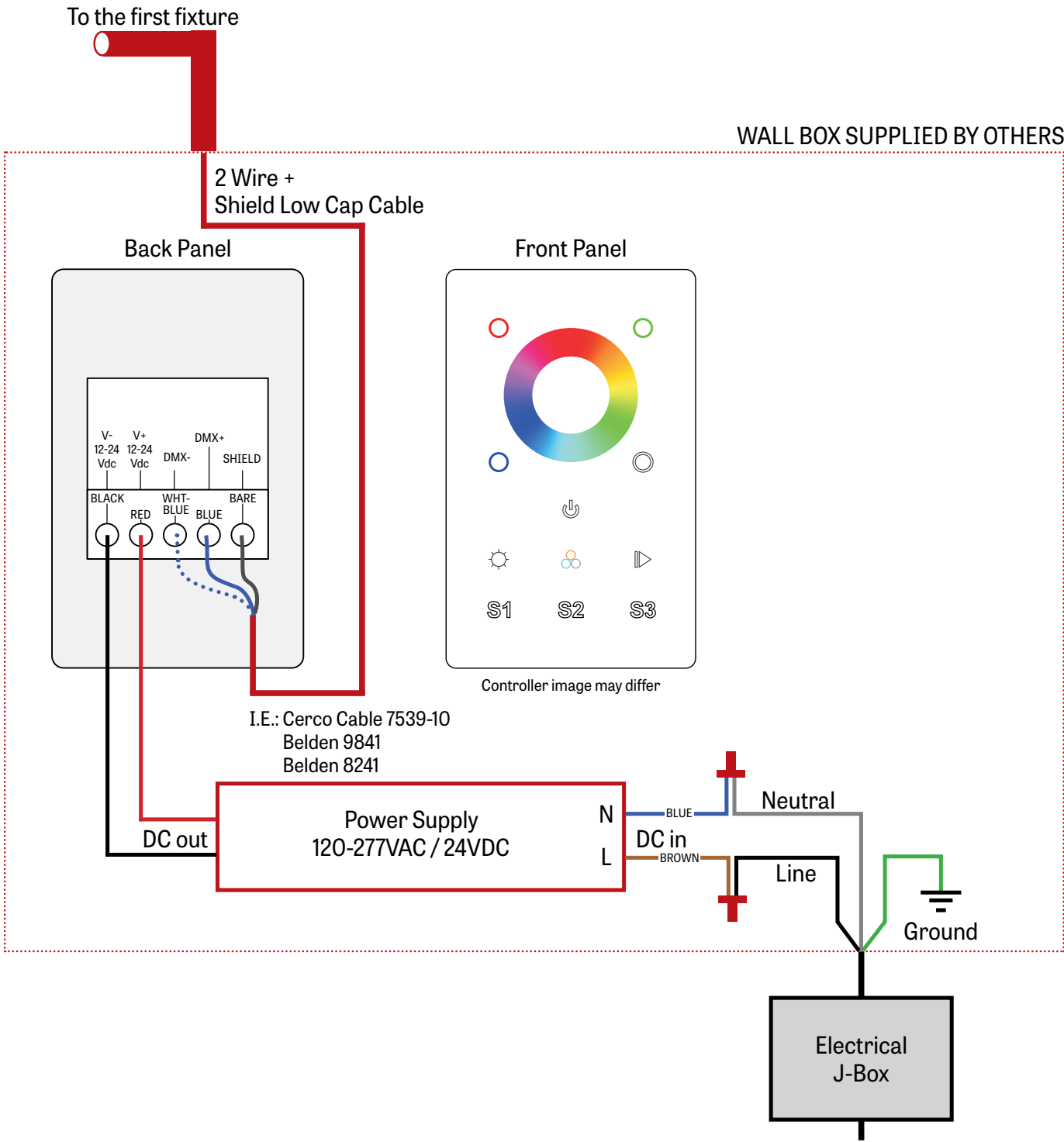

# VIA 5 RECESSED

DIRECT  
CHROMAWERX - QUADRO - RGBW

## 2 J-BOX DMX DAISY CHAIN DETAIL

Low capacitance DMX Cable from Previous Fixture

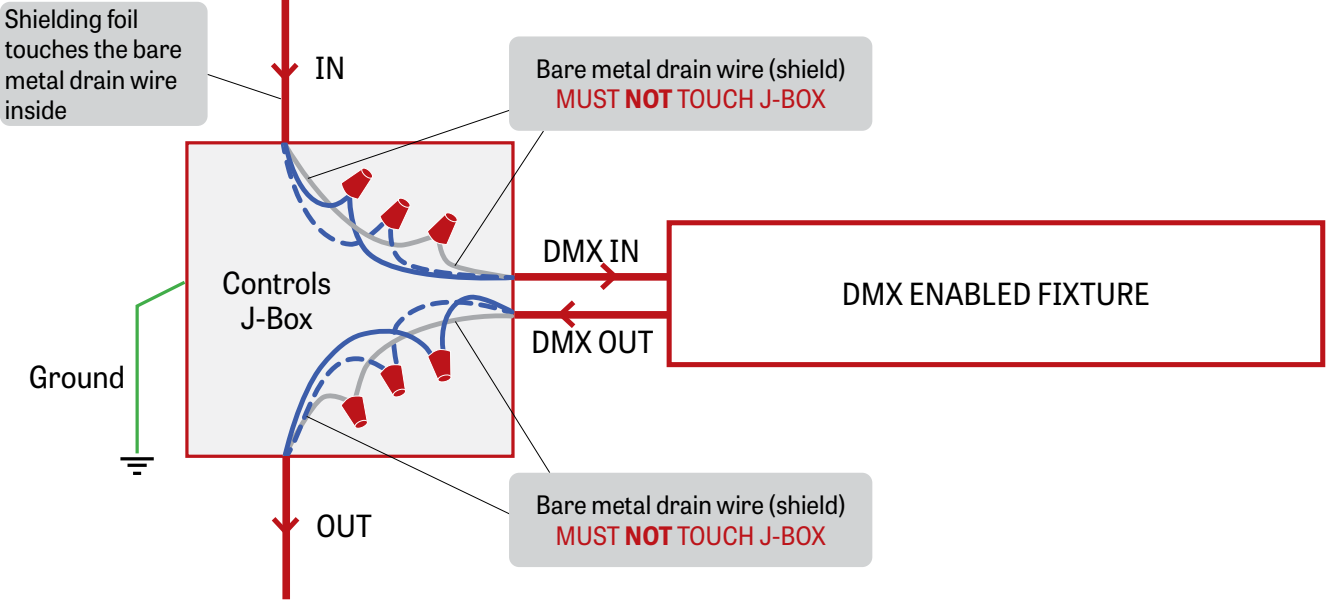

Low capacitance DMX cable to next fixture

## 3 DMX CONNECTION RECESSED & SURFACE

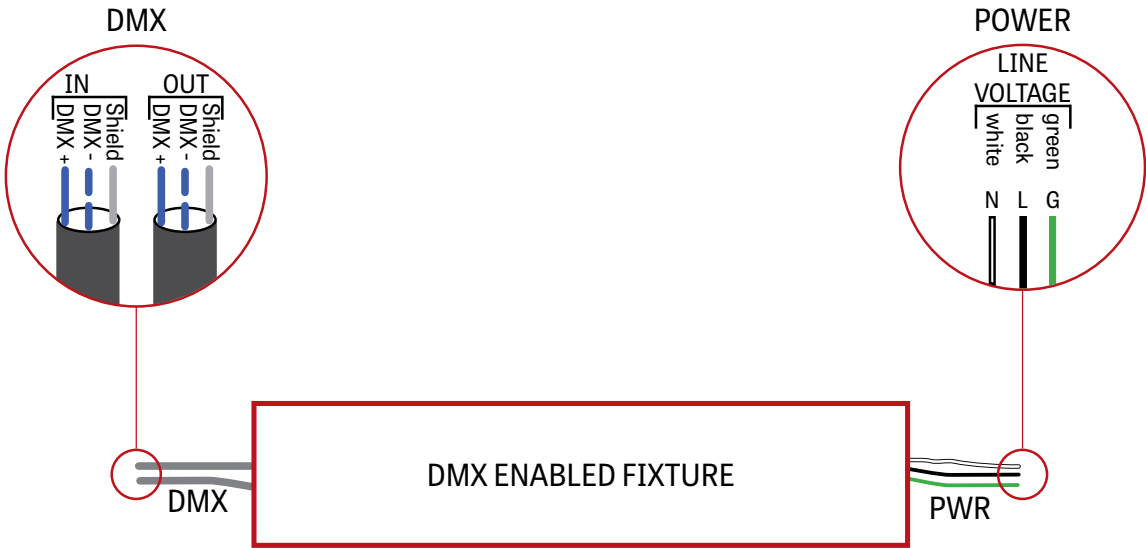

# VIA 5 RECESSED

DIRECT  
CHROMAWERX - QUADRO - RGBW

## 4 DMX LAST FIXTURE DETAIL

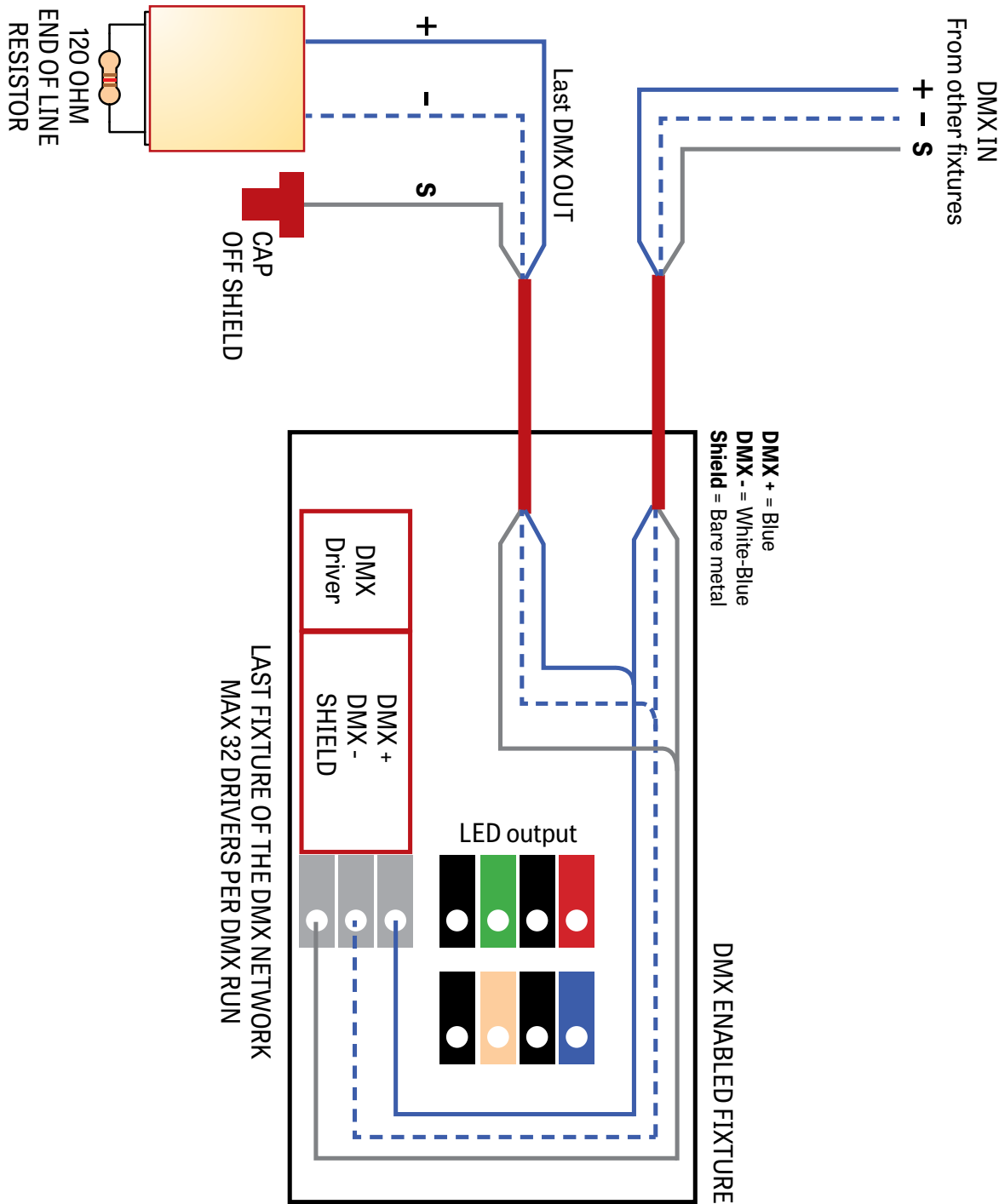

# VIA 5 RECESSED



DIRECT

CHROMAWERX - QUADRO - RGBW

## DMX WALL CONTROLLER

### WC1

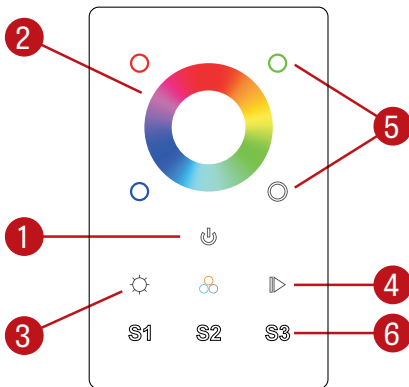

- (1) Power: Use this button to turn ON or OFF the RGBW fixture.
- (2) Color Wheel: The wheel is used to rapidly select a color (RGB colors only).
- (3) Brightness (RGB): Hold down this button to either increase or decrease the brightness of the current RGB selection. White will not be affected by the RGB brightness button.
- (4) Color Cycle: This button will start an animation, rotating between Reds Greens and Blues, the arrows allow the user to speed up or slow down the animation.
- (5) Individual Colors: By pressing and holding a color it will be possible to brighten or dim it. Quickly pressing a color will turn it OFF or turn it ON to its previous dim level.  
White: In order to activate or deactivate and dim the White channel, the White button needs to be used.
- (6) Scenes: By holding down one of the scenes button, the current color selection is saved. It can be later accessed by quickly pressing on one of the Scene buttons.

### WC2

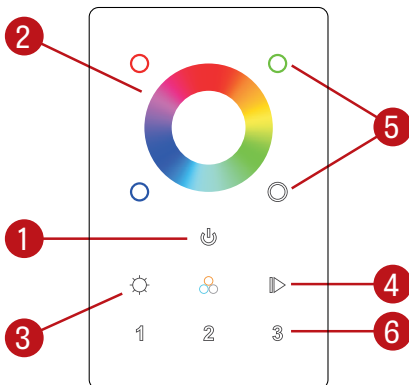

- (1) Power: Use this button to turn ON or OFF the RGBW fixture.
- (2) Color Wheel: The wheel is used to rapidly select a color (RGB colors only).
- (3) Brightness: Hold down this button to either increase or decrease the brightness of the current RGB selection. White will not be affected by the RGB brightness button.
- (4) Color Cycle: This button will start an animation, rotating between Reds Greens and Blues, the arrows allow the user to speed up or slow down the animation.
- (5) Individual Colors: By pressing a color it will be possible to brighten or dim that specific color.  
White: In order to activate or deactivate and dim the White channel, the White button needs to be used.
- (6) Zone: By holding down one of the zone buttons, a zone can be selected and controlled.

### Default DMX Addresses:

- 1 Red
- 2 Green
- 3 Blue
- 4 White