

# VIA 5 RECESSED VERTICAL



DIRECT  
CHROMAWERX - SOLA, DUO

IC RATED



DIRECT



HLO

Our elegant, flexible Via family is composed of linear, pendant, surface, recessed, and wall mounted luminaires. Each lighting fixture can be installed as a discrete luminaire or in continuous runs or patterns. Via 5 Recessed Vertical is offered with Lambertian optic.

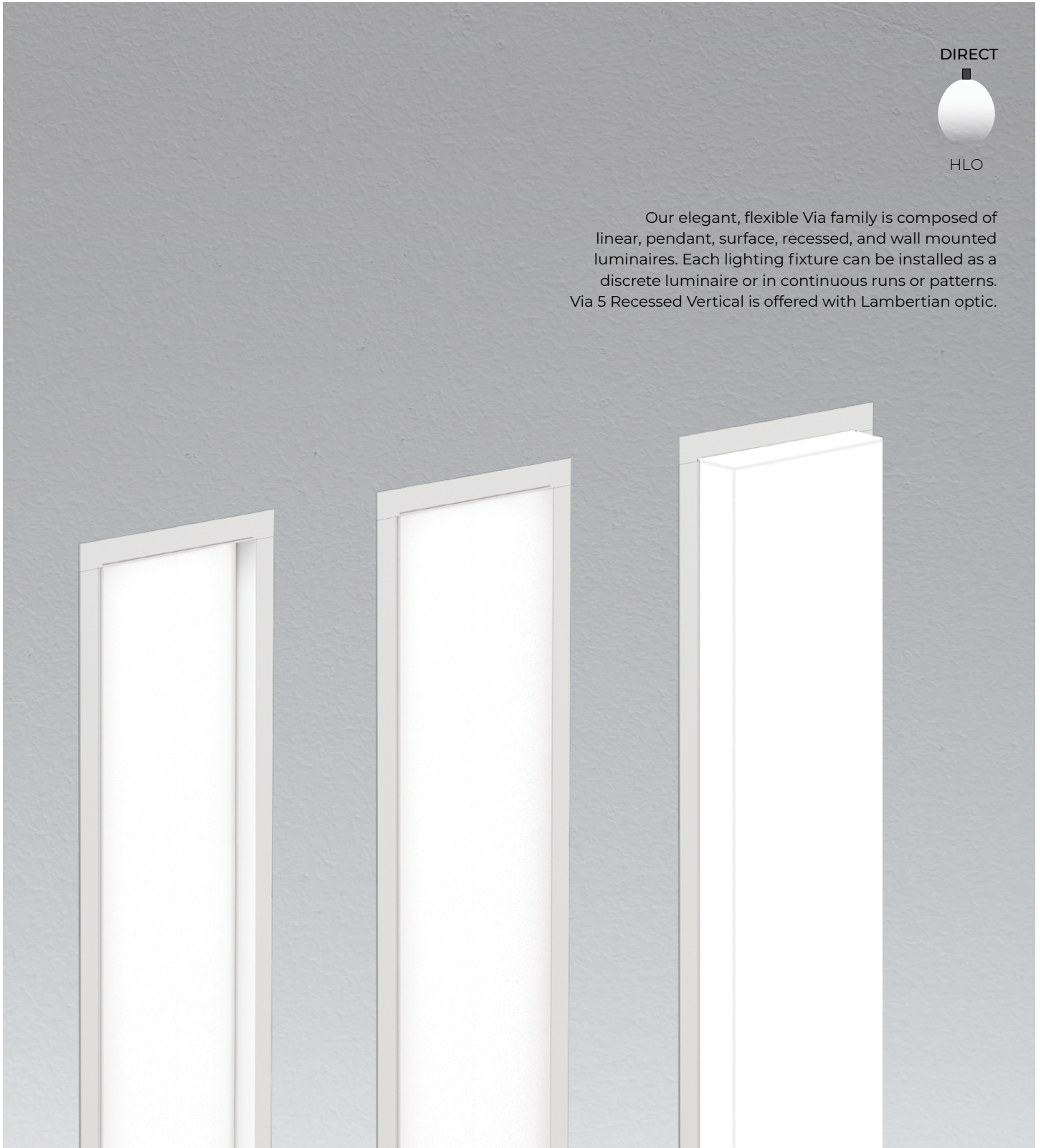

# VIA 5 RECESSED VERTICAL



DIRECT  
CHROMAWERX - SOLA, DUO

Project: \_\_\_\_\_

Type: \_\_\_\_\_

## Order Guide

LUMINAIRE ID	DISTRIBUTION	OPTIC	LENS POSITION	LIGHT SOURCE <sup>1</sup>
<b>VIA5RV</b>	<b>D</b>	<b>HLO</b>		
<b>VIA5RV</b> - Via 5" Recessed Vertical	<b>D</b> - Direct	<b>HLO</b> - High-Efficiency Lambertian Optic	<b>FH</b> - Flush <b>RG</b> - Regressed <b>1.0D</b> - 1.0" drop	<b>SOLA</b> - Dim-to-warm single channel control 35K to 22K <b>DUO</b> - Tunable white 2-channel control 65K to 27K  <sup>1</sup> Static white and Chromawerx QUADRO also available. Consult other spec sheets.

CRI	LUMEN PACKAGE	LUMINAIRE LENGTH	VOLTAGE
<b>80CRI</b> - 80+ CRI <b>90CRI</b> - 90+ CRI	<b>350LMF</b> <sup>2</sup> - Hypo output 350 lm/ft <b>500LMF</b> - Low output 500 lm/ft <b>750LMF</b> - Medium output 750 lm/ft <b>1000LMF</b> - High output 1000 lm/ft <b>1200LMF</b> - Ultra high output 1200 lm/ft  <sup>2</sup> Minimum 3' fixture.	<b>#FT#IN</b> <sup>3</sup> - Specify nominal length (#) in 1' and/or 1" increments  <b>Standard nominal lengths:</b> Single units: 2' to 12' Continuous runs: lengths over 12'  <sup>3</sup> - Minimum 2'. • Minimum 4' for DMX.	<b>120V</b> - 120V <b>277V</b> - 277V <b>UNV</b> - 120V-277V

DRIVER <sup>4</sup>	ELECTRICAL	POWER FEED	MOUNTING <sup>7</sup>	FINISH	OPTIONS <sup>9</sup>
<b>SOLA</b> <b>SDI</b> - Single 0-10V input  <b>DUO</b> <b>DMX</b> <sup>5,6</sup> - DMX <b>DDA</b> <sup>6</sup> - DALI DT6 <b>DDA8</b> <sup>6</sup> - DALI DT8 <b>DD1</b> - Dual 0-10V input for CCT/intensity <b>LD2</b> <sup>6</sup> - Lutron DALI-2 digital  <sup>4</sup> PoE (Power-over-Ethernet) compatible. Consult factory for details. <sup>5</sup> For more information, see pages 8 to 13. <sup>6</sup> On-site commissioning is required.	<b>1C</b>  <b>1C</b> - 1 circuit	<b>EF</b> - End feed <b>BF</b> - Back feed	<b>DTR</b> - Trim <b>DTL</b> - Trimless <b>DMF</b> - Drywall mud flange  <b>MF</b> <sup>8</sup> - Multiple flange mounting  <sup>7</sup> Transition mounting options also available (e.g. Recessed to Pendant/Surface), consult factory for details. <sup>8</sup> See page 4 for details.	<b>W</b> - Matte white <b>B</b> - Matte black <b>CF#</b> - Custom finish, specify RAL#	<b>FU120</b> - Fuse 120V <b>FU277</b> - Fuse 277V <b>FWC</b> - Flexible whip cable (6' std) <b>NA</b> - None  <sup>9</sup> Separate codes with a "+" if more than one is specified.

## Accessories

Optional, order separately

WALL CONTROLLER <sup>10</sup>	
<b>DMX</b>	<b>DD1</b>
<b>WCW##FT</b> <sup>11</sup> - DMX wall controller white <b>WCB##FT</b> <sup>11</sup> - DMX wall controller black	<b>TWCW##FT</b> <sup>12</sup> - Dual 0-10V wall controller white <b>TWCB##FT</b> <sup>12</sup> - Dual 0-10V wall controller black
<sup>10</sup> Specify wire length (##) in feet. <sup>11</sup> Available with DMX only. For more information, see pages 8 to 13, or consult factory. <sup>12</sup> Available with DD1 only. For more information, see page 14, or consult factory.	

# VIA 5 RECESSED VERTICAL



DIRECT  
CHROMAWERX - SOLA, DUO

## Dimensions

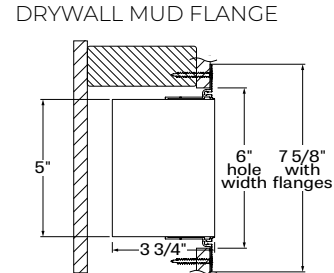
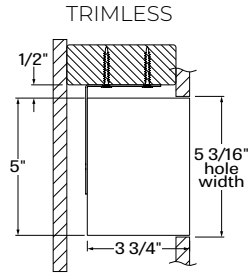
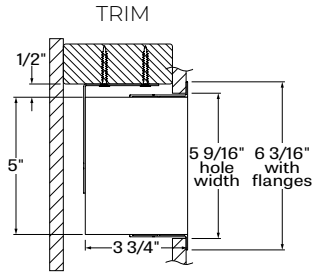

## LENS POSITIONS

Regressed Lens

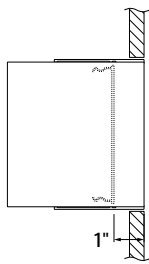

1.0" Drop Lens

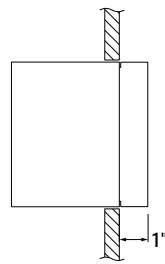

DIRECT  
CHROMAWERX - SOLA, DUO

## Multiple Flange Mounting Details

Multiple flange mounting can be specified when a fixture run needs to have a multiple flange recessed mounting detail. A drawing is required to clearly illustrate the application.

WALL CONDITION EXAMPLES (consult factory for project specific wall conditions)

DRYWALL/WOOD

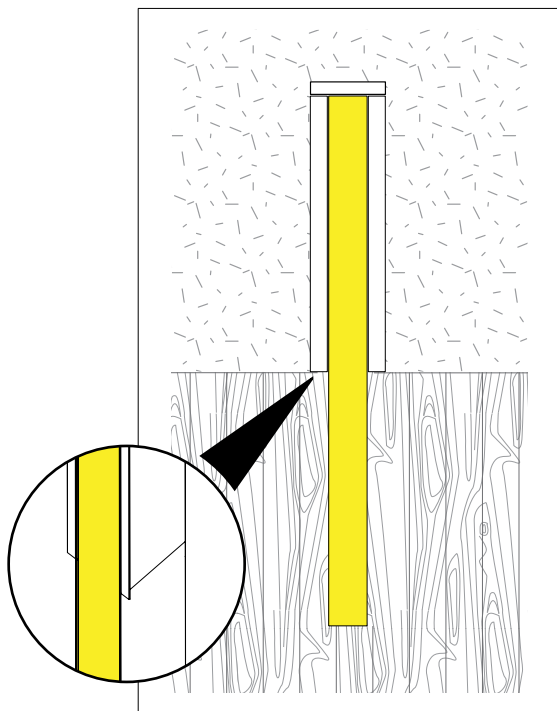

e.g. DTR/DTL  
Trim to Trimless

DRYWALL/WOOD

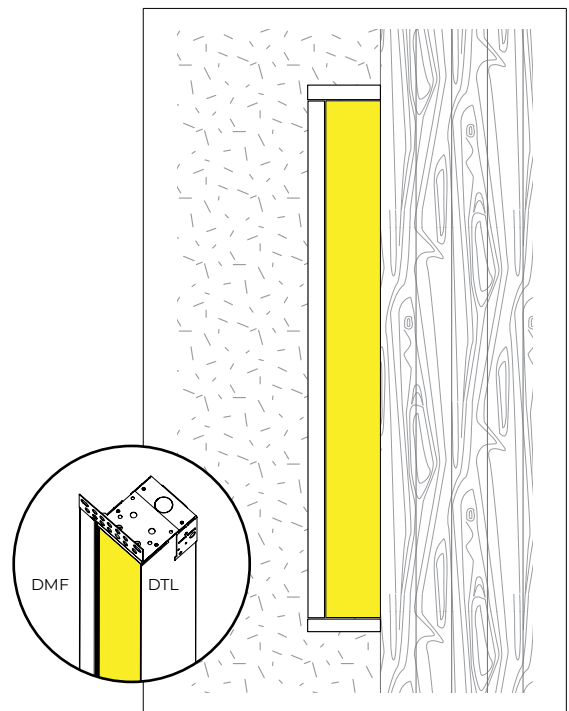

e.g. 3DMF/1DTL  
3 sides DMF and 1 long side DTL

All drawings are for illustrative purposes only.

## TRANSITION MOUNTING OPTIONS (consult factory for details)

Mounting condition alters along the run of the fixture.

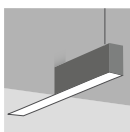

Recessed to Pendant

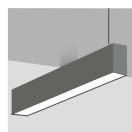

Surface to Pendant

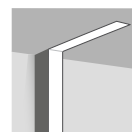

Surface to Recessed in corner

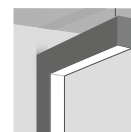

Surface to Pendant in corner

# VIA 5 RECESSED VERTICAL



DIRECT  
CHROMAWERX - SOLA, DUO

## Photometrics

Values calculated based on a 4' fixture at 3500K.

HLO (Flush lens)

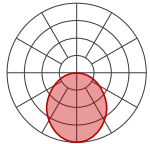

LM/FT	W/FT	LM/W
350	2.7	132
500	3.9	129
750	6.0	126
1000	8.2	122
1200	10.1	119

### MULTIPLIER TABLES

Use these tables to get results for different color temperatures and drop lenses.

SOLA

CCT	WATTS 80+ CRI / 90+ CRI	LPW 80+ CRI / 90+ CRI
3500K	1.00	1.00

DUO

CCT	WATTS 80+ CRI / 90+ CRI	LPW 80+ CRI / 90+ CRI
2700K	1.05	0.95
6500K	1.00	1.00

Multiplier - Drop lens

DIRECT LENS	WATTS	LPW
Flush lens	1.00	1.00
Drop lens 1.0"	0.88	1.12

DIRECT  
CHROMAWERX - SOLA, DUO

## Technical Specifications

### OPTIC

#### High-Efficiency Lambertian Optic (HLO)

The High-Efficiency Lambertian Optic (HLO) uses matte white reflectors to distribute LED output across 0.075" acrylic shielding, providing up to 88% transmission and good obscuration. Available as a flush lens or as a drop lens, the HLO has a spacing criterion of 1.22.

### LIGHT SOURCE

Custom linear array of alternating color temperature mid-flux LEDs are mounted directly to the housing for optimal thermal performance. For the DUO products, a color temperature range from 6500K-2700K is achievable with color points on or below the black body curve. For the SOLA products, a color temperature range from 3500K-2200K is controlled synchronously with intensity. Color consistency between fixtures is maintained to within 3 SDCM. All LEDs have been tested in accordance with IESNA LM-80-08 and the results have shown L80 lumen maintenance greater than 60,000 hours. Absolute product photometry is measured and presented in accordance with IESNA LM-79, unless otherwise indicated.

#### Chromawerx SOLA

It is a single-channel control that dims output while warming the color temperature in a pre-determined relationship. A simple analog control sends a common signal to dual output digital drivers, which are programmed to adjust a specially populated LED array to emulate the effect of dimming a filament source. Dimming range is programmable but the default option runs from 3500K at 100% of full power to 2200K at 5% of full power. CRI is maintained above 80 throughout the dimming range.

#### Chromawerx DUO

It is a two-channel control. It uses an analog (0-10V) protocol for separate control of luminaire CCT and intensity or a digital (DMX, DALI, and LD2) protocol for synchronous control of both warm and cool LED arrays to enable the user to set color temperature and light output. Commonly called "tunable white", Chromawerx two-channel control provides the range of cool (6500K) to warm (2700K) color that can be useful for helping to entrain circadian rhythms, stimulate alertness for improved educational and work productivity, and compensate for jet lag, among other applications. The Chromawerx drivers are programmed to limit maximum light output and power usage across all color temperatures. CRI is maintained above 80. When paired with DALI drivers (DDA/DDA8), color tuning follows a linear dimming curve.

ANSI C78.377-2015

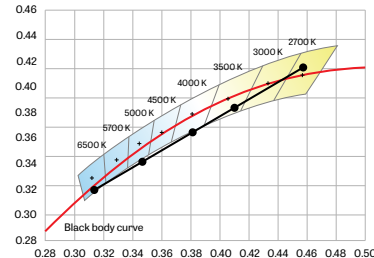

### LUMINAIRE LENGTH

Via 5 is available in standard lengths of 2' to 12'. Continuous runs are available for run lengths over 12'. Exact run length must be noted in the product code. The minimum length is 2', or 4' for DMX. Lengths can be ordered in 1' and/or 1" increments. All individual sections are joined together onsite using the joiner kits provided. Lumenwerx offers joiner kits that are extremely simple to work with in the field and result in a fixture that appears virtually seamless with no light leak at any connection.

### ELECTRICAL

#### SOLA

##### SDI

Factory-set, adjustable output current LED driver with universal (120-277 VAC) input. Using a single 0-10V control signal, the light output warms in color temperature as it dims down to 1% and 2200K. At maximum driver load, efficiency<86%, PF>0.9, THD<20%.

#### DUO

##### DMX

Factory-set adjustable output current electronic driver with 120-277 VAC line input. Using DMX wall controls (optionally supplied by Lumenwerx) or an existing DMX control system, both channels of LEDs are independently adjustable. Each DMX driver can be independently addressed using the built-in RDM (Remote Device Management) in the field. Dimming down to 1% is attainable. Rated life (90% survivorship) of 50,000 hours at 50°C maximum ambient temperature. At maximum driver load, efficiency<84%, PF>0.9, THD<20%.

##### DALI

Factory-set adjustable output current electronic driver with 120-277 VAC line input. Using an existing DALI control system (supplied by others), one control channel adjusts the fixture color temperature, and the other control channel adjusts fixture brightness. With DALI Type 6, two DALI addresses are required to control both channels. With DALI Type 8, one DALI address is required to control both channels. Dimming down to 1% is attainable. Rated life (90% survivorship) of 50,000 hours at 50°C maximum ambient temperature. At maximum driver load, efficiency<84%, PF>0.9, THD<20%.

# VIA 5 RECESSED VERTICAL



DIRECT  
CHROMAWERX - SOLA, DUO

## DD1

Factory-set adjustable output current LED driver with universal (120-277 VAC) input. Controlled via two individual 0-10V signals, one for setting light output down to a minimum of 1% and the other for adjusting the CCT (default range of 6500K-2700K). Rated life of 50,000 hours at 70°C maximum driver case temperature and 100% load conditions. Typical efficiency of 86%, PF>0.9, THD<20% at 100% load conditions.

## LD2

Lutron DALI-2 digital drivers provide a high-performance tunable white solution with single-address digital control. Guaranteed performance and compatibility when used with Lutron DALI-2 controls.

## **PoE**

Depending on the PoE manufacturer selected, Lumenwerx will install the node in factory as either integral to the luminaire or as a remote module. Factory programming of the PoE node may or may not enable the following functionalities: lumen package, DUO (tunable white), QUADRO (RGBW), emergency battery backup, and sensor integration. These must be addressed and evaluated on a case-by-case basis.

## **MOUNTING**

Recessed wall mounting is available with trim, trimless, or mud flange options.

## **FINISH**

**Interior:** 95%, reflective matte powder coated white paint  
**Exterior:** Matte white or matte black powder coating. Custom finishes are also available.

## **CONSTRUCTION**

**Housing:** Extruded aluminum, up to 90% recycled content  
**Interior brackets:** Die-formed cold rolled sheet steel  
**Joining system:** Die-cast zinc  
**Reflectors:** Die-formed cold rolled steel, 95% reflective matte white painted  
**Lens:** Acrylic  
**Drop lens:** Extruded with glued end caps  
**Recessed flanges:** Extruded aluminum, up to 90% recycled content  
**Mud flange:** Extruded aluminum, up to 90% recycled content  
**Slip-through bracket:** Die-formed galvanized sheet  
**End plate:** Die-formed cold rolled sheet steel

## **WEIGHT**

**4':** 11.78 lbs - 5.35 kg  
**8':** 23.79 lbs - 10.8 kg  
**12':** 35.24 lbs - 16 kg

## **CERTIFICATIONS**

**ETL:** Rated for indoor dry/damp locations. Conforms to UL Standard 1598 and certified to CAN/CSA Standard C22.2 No. 250.0.  
**IC rated:** Suitable for direct contact with insulation

## **WARRANTY**

Lumenwerx provides a five-year limited warranty on electrical and mechanical performance of the luminaires, including the LED boards, drivers, and auxiliary electronics. Lumenwerx will repair or replace defective luminaires or components at our discretion, provided they have been installed and operated in accordance with our specifications. Other limitations apply, please refer to the full warranty on our website.  
Wall controllers are covered by the manufacturer warranty.

# VIA 5 RECESSED VERTICAL



DIRECT  
CHROMAWERX - SOLA, DUO

## DUO DMX SPECIFICATION

A qualified DMX integrator is required to assure proper installation and commissioning of the DMX network. **When placing the PO, please provide the contact information of your DMX integrator.**

Please answer the following questions to help us identify your DMX network requirements.

YES

Do you require a wall controller provided by Lumenwerx?

NO

DMX controller supplied by Lumenwerx

DMX control system supplied by others. Lumenwerx will supply DMX-enabled fixtures with default DMX addressing. See following pages for technical DMX informations. ✓

**How many zones do you have?**

A zone consists of one or more luminaires behaving identically.



1 Zone



2 Zones

**How to calculate the required number of drivers:**

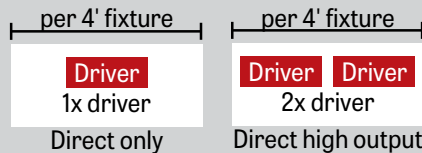

To Calculate # of drivers

1 - 4 Zones

5 or more Zones

Do you have more than 32 drivers in total?

NO

YES

Order a standard Lumenwerx wall controller.

### WALL CONTROLLER

**WCW** - wall controller white  
**WCB** - wall controller black

Add the control code at the end of your order code. Please provide a fixture layout or RCP (Reflected Ceiling Plan) showing the locations of the DMX fixtures, zones and the DMX wall controller. Refer to your DMX integrator for the installation. ✓

Subject to factory evaluation. Please contact our controls specialist at [controls@lumenwerx.com](mailto:controls@lumenwerx.com). Additional cost and equipment will be required. ✓

Subject to factory evaluation and approval. Please contact our controls specialist at [controls@lumenwerx.com](mailto:controls@lumenwerx.com). Additional cost and equipment will be required. ✓

# VIA 5 RECESSED VERTICAL



DIRECT  
CHROMAWERX - SOLA, DUO

## GENERIC DMX NETWORK ARCHITECTURE

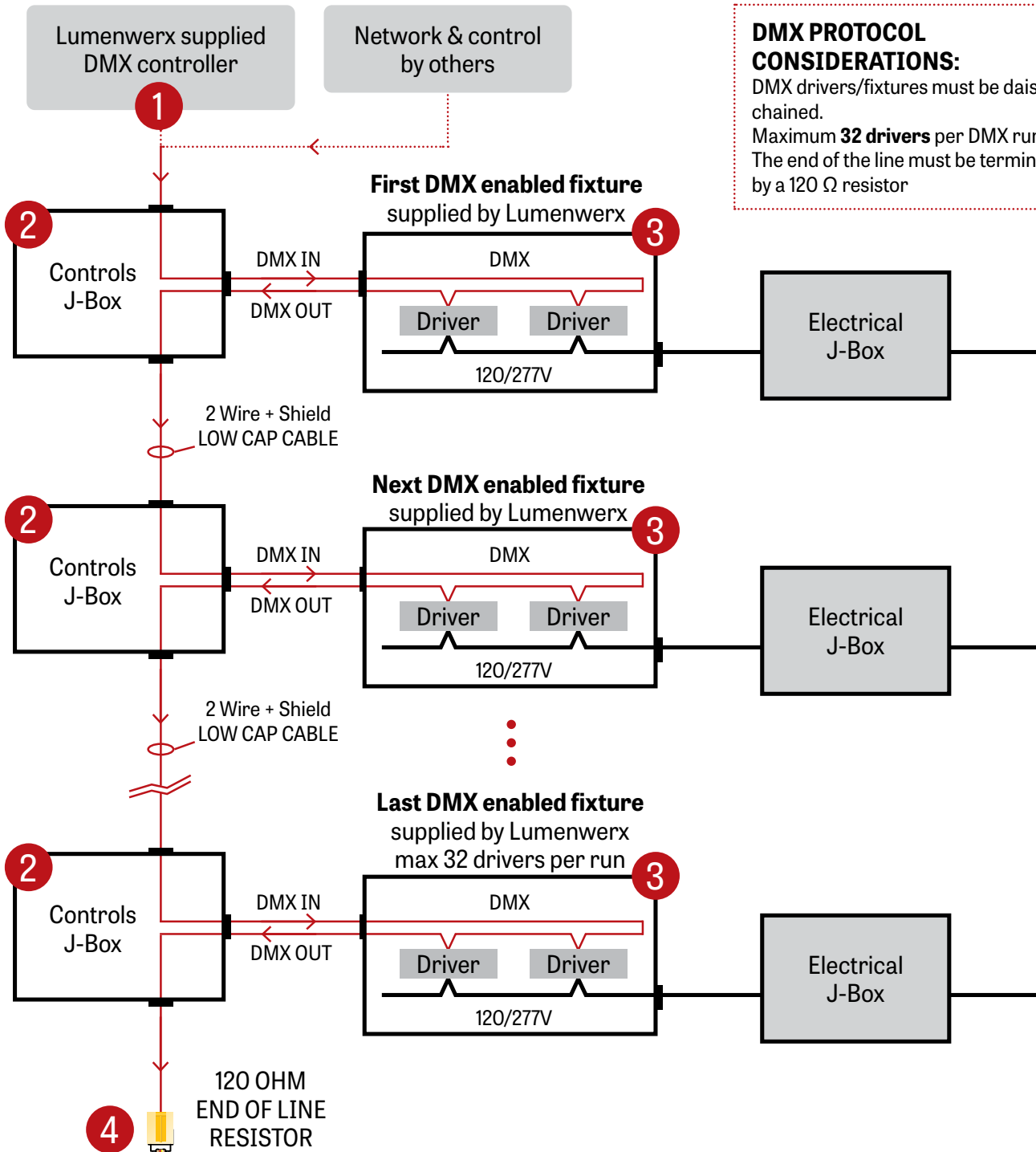

**DMX PROTOCOL CONSIDERATIONS:**  
DMX drivers/fixtures must be daisy chained.  
Maximum **32 drivers** per DMX run.  
The end of the line must be terminated by a 120 Ω resistor

# VIA 5 RECESSED VERTICAL



DIRECT  
CHROMAWERX - SOLA, DUO

## 1 LUMENWERX SUPPLIED DMX CONTROLLER

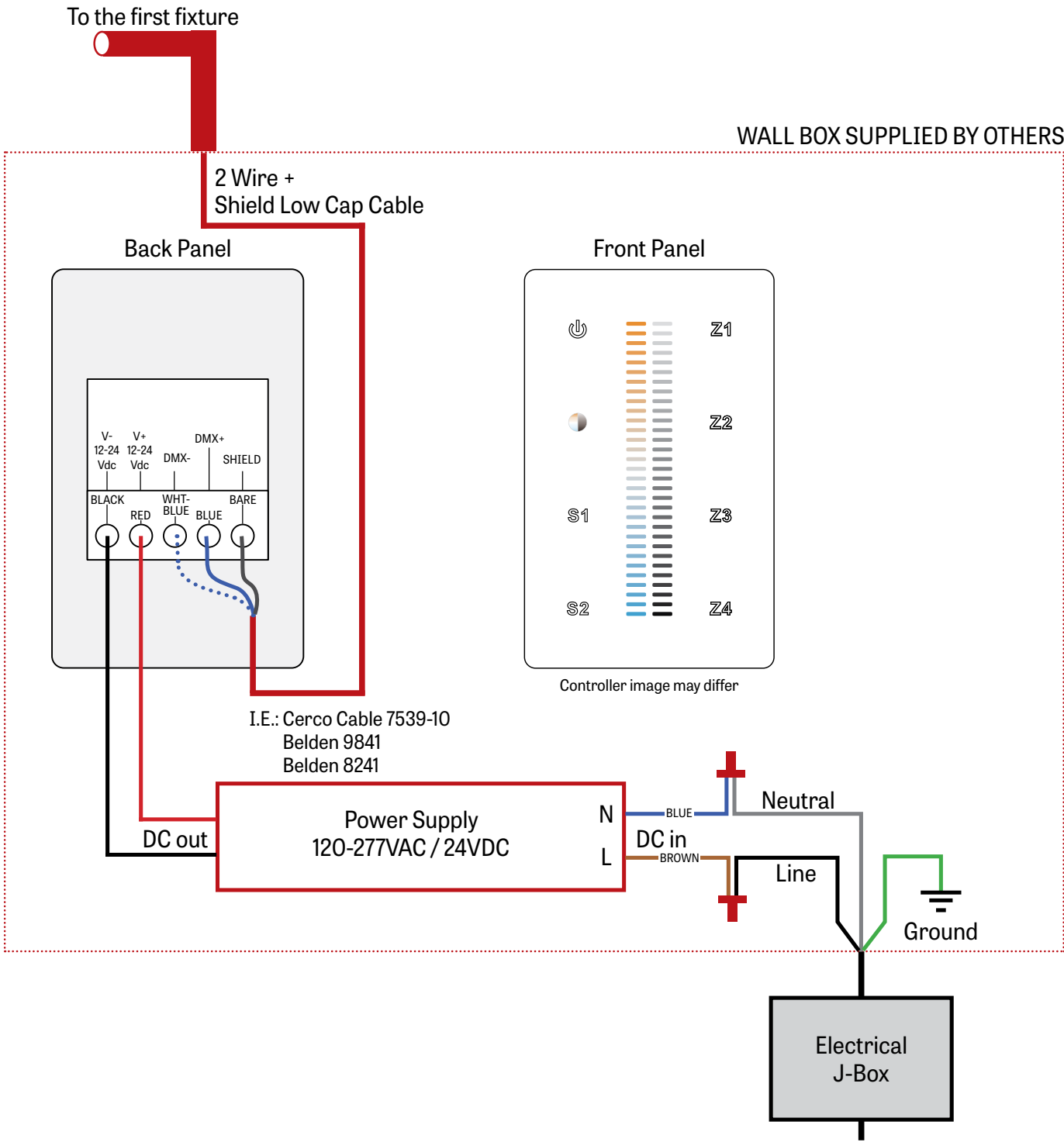

DIRECT  
CHROMAWERX - SOLA, DUO

## 2 J-BOX DMX DAISY CHAIN DETAIL

Low capacitance DMX Cable from Previous Fixture

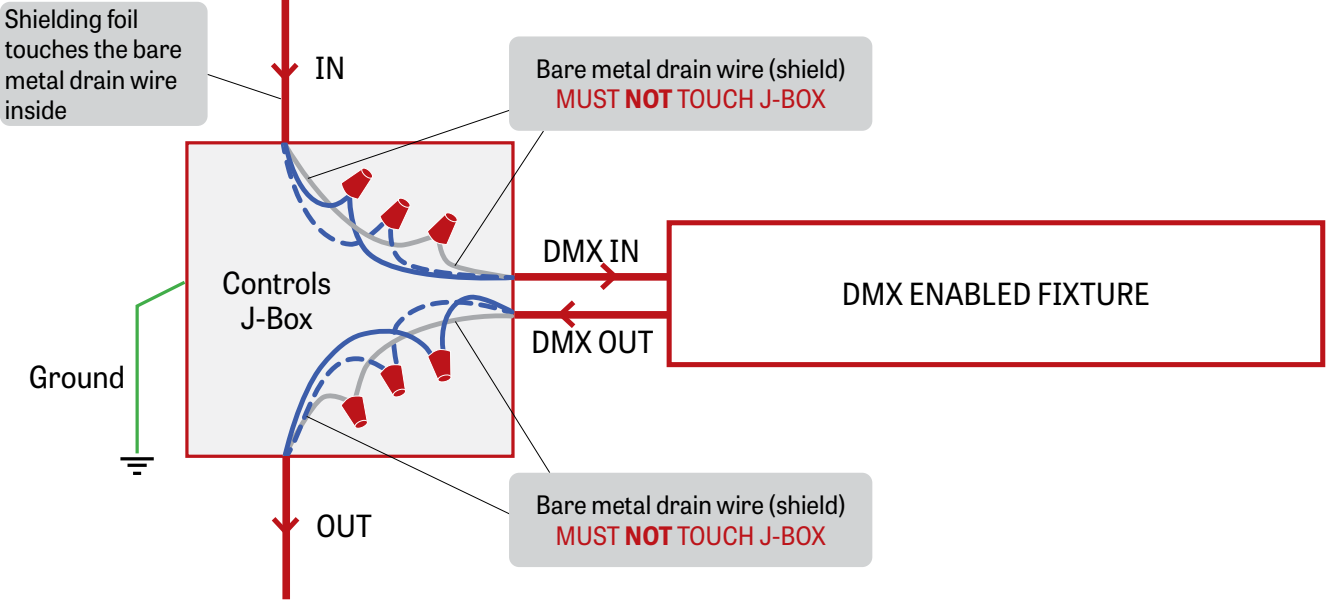

Low capacitance DMX cable to next fixture

## 3 DMX CONNECTION RECESSED & SURFACE

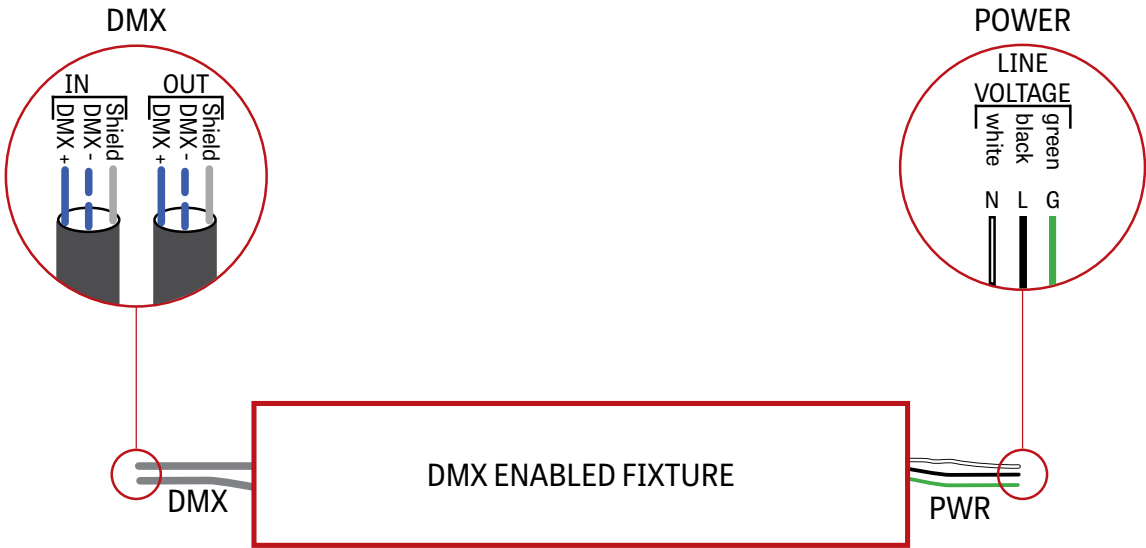

# VIA 5 RECESSED VERTICAL

DIRECT  
CHROMAWERX - SOLA, DUO

## 4 DMX LAST FIXTURE DETAIL

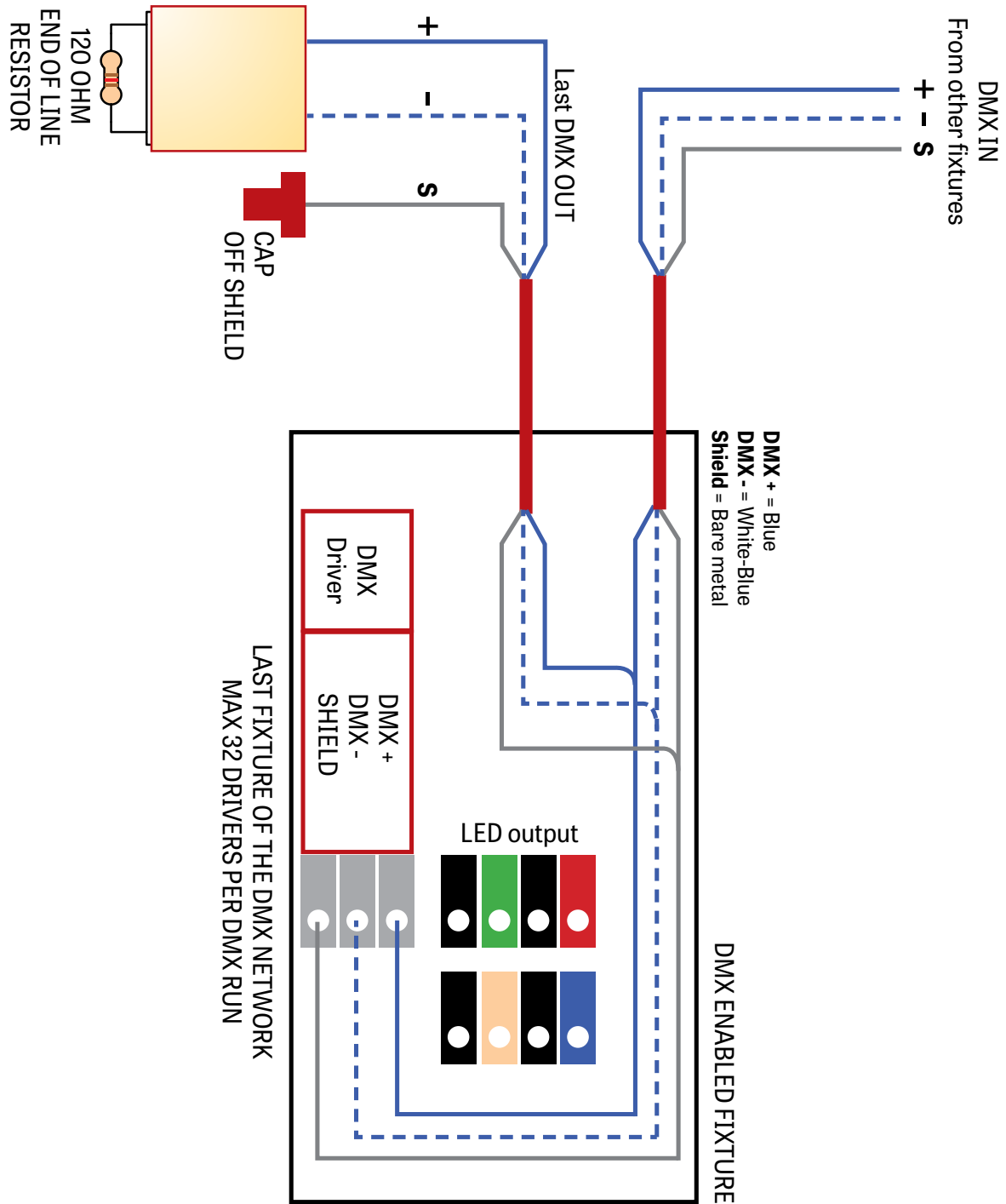

# VIA 5 RECESSED VERTICAL



DIRECT  
CHROMAWERX - SOLA, DUO

## DMX WALL CONTROLLER

### DUO 1-4 ZONE

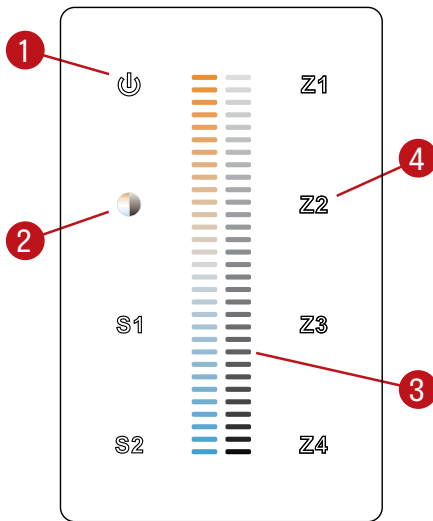

- (1) Power: Use this button to turn ON or OFF the fixture.
- (2) Brightness/CCT: Use the color/brightness toggle button to choose between color/brightness. When Blue: brightness is selected, when Yellow: color is selected.
- (3) Slider: Depending on the mode chosen in step 2, the slider will allow the user to set desired color or brightness.
- (4) Zone select: Up to 4 zones can be selected either independently or together. Once selected, the commands will be sent to the zone identified by a Blue LED.

### Default DMX Addresses:

- 1 Warm
- 2 Cool

# VIA 5 RECESSED VERTICAL



DIRECT  
CHROMAWERX - SOLA, DUO

## DUAL 0-10V WALL CONTROLLER

### Front Panel

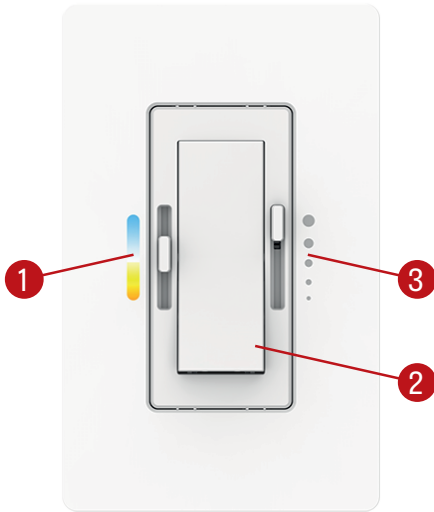

Controller image may differ

### Dimensions

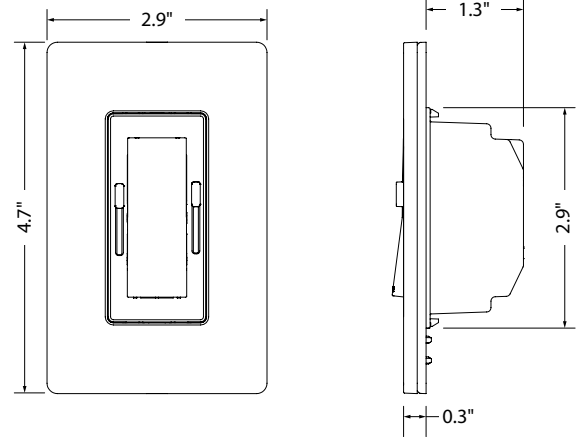

- (1) CCT control: Use this button to adjust the color temperature.
- (2) On/Off switch: Use this button to turn ON or OFF the fixture.
- (3) Dimming control: Use this button to adjust the brightness.

### Wiring Diagram

