

# Voilà

## 4" Cylinder Pendant

Project: \_\_\_\_\_

Type: \_\_\_\_\_



Voilà 4" Cylinders feature innovative Hyflex™ optics for precise beam control. Voilà Cylinders are offered in round and square form factor and in three height options, all with on-board and remote driver options. The Voilà COB source matches other Lumenwerx luminaires, with 90+ CRI and 2-step color consistency, and is available with Chromawerx SOLA and DUO. Complete Voilà offering includes 2" and 4" apertures; downlights, adjustables, and wall washers; round and square trim; and cylinders.

### Performance

LUMEN OUTPUT <sup>1</sup>	WATTS	EFFICACY LM/W
1501 lm	14 W	107 lm/W
2037 lm	20 W	102 lm/W

<sup>1</sup> Lumens packages are assuming 3500K, 80+ CRI, 30° beam, round white baffle

Delivered Lumens for Round White Flush (1P) Baffles at 35K

CRI	90+ CRI								
-----	---------	--	--	--	--	--	--	--	--

BEAM	10	20	30	40	50	60	75	90
Low - 13.8 W	1257	1203	1410	1424	1379	1363	1333	1302
Medium - 19.7 W	1576	1508	1912	1933	1871	1849	1808	1766

### Aperture Size

4" (Round)



### Baffle Position

Flush, ½" & 1" regress baffles

### Height

4.5", 6", 9"

### Mounting Types

Pendant

### Cylinder & Cuboid Finishes

Textured matte white

Textured matte black

Custom RAL

### Color Temperatures

2700K

3000K

3500K

4000K

SOLA

DUO

Delivered 1294-2078 lm  
14-20 Watts, up to 111 lm/W

### Integral Drivers

0-10V, TRIAC & ELV

### Remote Drivers

0-10V, TRIAC & ELV  
eldoLED  
Lutron  
DMX  
Remote emergency battery pack

### Cylinder

### Product Specification

LUMINAIRE ID	CYLINDER	BAFFLE	LENS		
<b>VO4CYP</b>					
<b>VO4CYP</b> - Voila 4" Cylinder Pendant	<b>HEIGHT</b> 4.5 <sup>1</sup> - 4.5" 6 <sup>1</sup> - 6" 9 - 9" <sup>1</sup> Available with integral canopy option (INT) only when specified with integral driver.	<b>FINISH</b> TMW - Textured matte white TMB - Textured matte black CF# - Custom finish, specify RAL# (e.g. <b>CF1028</b> )	<b>POSITION</b> 1P - Flush 2P <sup>23</sup> - 1/2" 3P <sup>24</sup> - 1" <sup>2</sup> Only available with 50° beam or lower. <sup>3</sup> Not available with 4.5" length. <sup>4</sup> Not available with 4.5" and 6" lengths.	<b>FINISH</b> TMW - Textured matte white TMB - Textured matte black CF# - Custom finish, specify RAL# (e.g. <b>CF1028</b> )	<b>SDL</b> - Soft diffused lens <b>FDL</b> - Frosted diffused lens <b>NOL</b> - No lens

### Light Element

LIGHT SOURCE	BEAM	COLOR QUALITY	CRI	COLOR TEMP	OPTION
<b>SW</b> - Static white	10 - 10° Narrow spot 20 - 20° Spot 30 - 30° Narrow flood 40 - 40° Flood 50 - 50° Wide flood 60 - 60° Very wide flood 75 - 75° Very wide flood 90 - 90° Open flood	<b>2</b> - 2 Step MacAdam Ellipse	80 - 80+ CRI 90 - 90+ CRI 95 - 95+ CRI	27 - 2700K 30 - 3000K 35 - 3500K 40 - 4000K	<b>HEX</b> <sup>7</sup> - Hex louver <b>NA</b> - None <sup>7</sup> Not available with 60°/75°/90° beam options.
<b>SOLA</b> - Dim-to-warm <b>DUO</b> - Tunable white	20 <sup>5</sup> - 20° Spot 40 <sup>6</sup> - 40° Flood 50 <sup>6</sup> - 50° Wide flood 60 <sup>6</sup> - 60° Very wide flood 75 <sup>6</sup> - 75° Very wide flood 90 <sup>6</sup> - 90° Open flood <sup>5</sup> Available with low output only. <sup>6</sup> Available with high output only.	<b>3</b> - 3 Step MacAdam Ellipse	<b>90</b> - 90+ CRI ( <b>SOLA</b> and <b>DUO</b> )	<b>SOLA</b> - Dim-to-warm 35K-22K <b>DUO</b> - Tunable white 27K-65K	

### Power Supply & Dimming

VOLTAGE	WATTAGE (80+ CRI) <sup>9</sup>	DIMMING		
120 - 120V <b>UNV</b> - 120V-277V <b>347</b> <sup>8</sup> - 347V <sup>8</sup> Available with remote 0-10V dimming options RDI and RSD1 only. Consult factory for details.	<b>14W</b> - Low output 1294-1532 lm <b>20W</b> - Medium output 1623-2078 lm <sup>9</sup> For delivered lumens, see multiplier tables on page 3.	<b>INTEGRAL</b> <b>DI</b> - 1% 0-10V <b>ELV</b> <sup>10</sup> - ELV 120V <b>TRI</b> <sup>10</sup> - TRIAC 120V <sup>10</sup> Available with 120V only.	<b>REMOTE</b> <b>RD1</b> - 1% 0-10V <b>RELV</b> <sup>11</sup> - ELV 120V <b>RTRI</b> <sup>11</sup> - TRIAC 120V <b>RLDE1</b> <sup>12</sup> - Lutron Hi-lume 1% Eco <b>RDA</b> <sup>12</sup> - DALI <b>RELD0</b> - eldoLED 0.1% <b>RELD1</b> - eldoLED 1% <sup>11</sup> Available with 120V only. <sup>12</sup> On-site commissioning is required.	<b>+EB</b> <sup>13</sup> - Emergency battery <sup>13</sup> Specify with remote dimming only. The code will be like the following example: <b>RD1 + EB</b> .
	<b>SOLA</b> <b>13W</b> - Low output 920 lm (20° only) <b>20W</b> - High output 1500-1660 lm (40° and up) <b>DUO</b> <b>10W</b> - Low output 700 lm (20° only) <b>20W</b> - High output 1100-1200 lm (40° and up)	<b>SOLA</b> <b>SD1</b> - Single 0-10V input	<b>SOLA</b> <b>RSD1</b> - Single 0-10V input <b>DUO</b> <b>RDMX</b> <sup>12</sup> - DMX, to specify, see pages 6 to 8 <b>RDDA</b> <sup>12</sup> - DALI DT6 <b>RDDA8</b> - DALI DT8 <b>RDD1</b> - Dual 0-10V input for CCT/intensity <b>RLD2</b> <sup>12</sup> - Lutron DALI-2 digital	

### Mounting

CANOPY	HANGER		
<b>TYPE</b> <b>REG</b> <sup>14</sup> - Regular canopy, 4" octagonal junction box, round canopy <b>CD</b> <sup>14</sup> - Conduit feed, round canopy <b>INT</b> - Integral driver on junction box, round canopy (integral driver only) <sup>14</sup> Not available with 4.5" and 6" lengths when specified with integral driver.	<b>FINISH</b> <b>TMW</b> - Textured matte white <b>TMB</b> - Textured matte black <b>CF#</b> - Custom finish, specify RAL# (e.g. <b>CF1028</b> )	<b>POWER CORD</b> <sup>15</sup> <b>BPC###IN</b> - Black PVC <b>WPC###IN</b> - White PVC <sup>15</sup> Min 18" - max 72", specify length (##) in inches.	<b>STEM</b> <sup>16</sup> <b>BKS###IN</b> - Textured black stem <b>WHS###IN</b> - Textured white stem <sup>16</sup> Min 18" - max 48", specify length (##) in inches.

## Photometrics

Please follow the multiplier tables to ensure correct lumen value. Beams, baffle color, lensing, CCT, CRI, baffle shape and accessories will change the lumen value.

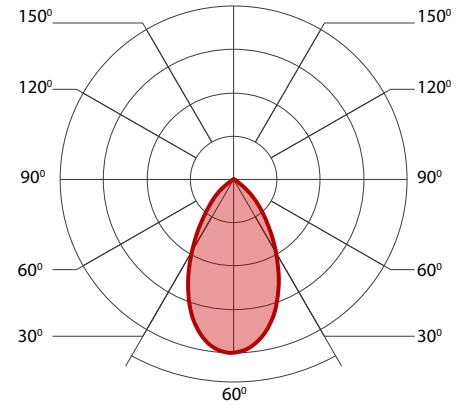
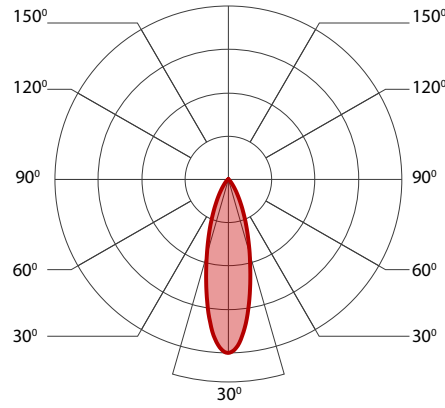
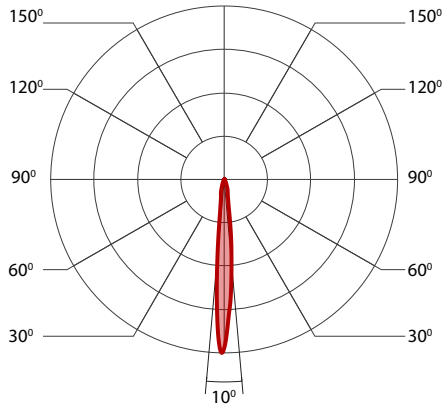

Delivered Lumens for Round White Flush (1P) Baffles - At 35K

BEAM	80+ CRI								90+ CRI							
	10	20	30	40	50	60	75	90	10	20	30	40	50	60	75	90
Low - 13.8 W	1348	1294	1501	1532	1475	1455	1424	1394	1257	1203	1410	1424	1379	1363	1333	1302
Medium - 19.7 W	1692	1623	2037	2078	1995	1975	1933	1892	1576	1508	1912	1933	1871	1849	1808	1766

Delivered Lumens - At 30K

BEAM	95+ CRI							
	10	20	30	40	50	60	75	90
Low - 13.8 W	1080	1053	1213	1225	1186	1172	1146	1120
Medium - 19.7 W	1355	1297	1644	1663	1609	1590	1555	1519

Beam Angle

BAFFLE POSITION	ACTUAL BEAM ANGLE							
	10	20	30	40	50	60	75	90
4" Cuboid Flush	11.4	16.8	29.0	39.1	47.2	58.2	75.1	90.5
4" Cuboid Regressed 1/2"	11.4	16.8	28.8	38.7	46.3	56.6	72.1	86.3
4" Cuboid Regressed 1"	11.4	16.7	28.3	37.5	44.5	54.0	68.8	81.2

Efficacy Based on Delivered Lumens - High 19.7 W

BEAM	LPW							
	10	20	30	40	50	60	75	90
80+ CRI	86	82	103	105	101	100	98	96
90+ CRI	80	77	97	98	95	94	92	90
95+ CRI	69	66	83	84	82	81	79	77

SOLA and DUO Max Wattage

BEAM	90+ CRI							
	10	20	30	40	50	60	75	90
DUO	NA	10	NA	19	19	19	19	19
SOLA	NA	13	NA	20	20	20	20	20

Multiplier - Optical Options

LENS AND LOUVERS	
No lens	1
Soft diffused lens	0.94
Frosted lens	0.78
Hex louver	0.82

Multiplier - Efficacy

BAFFLE POSITION	10	20	30	40	50	60	75	90
Flush	1	1	1	1	1	1	1	1
Regressed 1/2"	0.99	0.99	0.99	0.97	0.98	0.98	0.98	0.97
Regressed 1"	0.97	0.97	0.97	0.96	0.96	0.95	0.94	0.93

Multiplier - CCT

CCT	
2700K	0.9
3000K	0.95
3500K	1
4000K	1.05

Multiplier - Baffle Color and Shape

BAFFLE VARIABLES		
White	Round	1
Black	Round	0.95

For SOLA and DUO, please consult factory.

Project: \_\_\_\_\_

Type: \_\_\_\_\_

## Technical Specification

**DESCRIPTION** Ø 4" cylinder with multiple height, output, color, and dimming options in a variety of standard or custom finishes.

### CYLINDER

Die-cast and extruded aluminum.

**Power Cord:** Black and white PVC

**Stem:** Ø 1/2" rigid stem 18" to 48" standard length

**Canopy:** Regular and conduit (when recessed wiring is not possible).

**Finish:** Powder coated paint, textured white & black matte. Custom colors also available (provide RAL #)

### LIGHT ELEMENT

**LED Module:** Integral COB module. 90+ CRI and 2 SDCM, Standard with options of 80+ CRI, or 95+ CRI. L80 > 60,000 hours

**Light Output:** From 1294-2078 lumens

**HyFlex™ Optics:** Proprietary TIR/reflector with field interchangeable beam smoothing lenses.

**Thermal Management:** Cold-forged aluminum heat sink to maximize thermal dissipation.

### BAFFLE

Die-cast aluminum.

**Baffle position:** Flush, ½" and 1" regress

**CHROMAWERX SOLA** (dim-to-warm) and **DUO** (tunable white). See page 5 for more information.

### ELECTRICAL

**Integral:** 0-10V, ELV, TRIAC

**Remote:** 0-10V, ELV, TRIAC

Lutron Hi-Lume EcoSystem, DALI, eldoLED 0.1%, eldoLED 1%, DMX, Lutron DALI-2 digital.

**Emergency Options:** Emergency battery back-up option available as remote (Fullham, Bodine, or IOTA). The battery provides 10W of power.

**ENVIRONMENT** Ambient temperature at fixture location shall be within 0°C/32°F - 25°C/77°F, indoor dry or damp as well as outdoor damp use (canopies or marquees).

**LISTING** cETLus listed to UL 1598 and CAN/CSA Standard C22.2 No. 250.0

**WARRANTY** 5 year limited warranty on LED module and power supply. Guaranteed to maintain 70% lumen maintenance.

## Light

### Mounting

Stem - Min 18" - Max 48" - Ø 1/2" threaded steel tube  
PVC Power Cord - Black, White

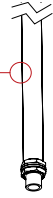

### Cylinder Housing

4.5", 6", 9" Height  
Textured Matte White Finish  
Textured Matte Black Finish  
Custom Finish Specify RAL#

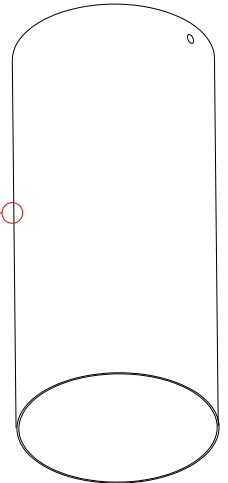

### Light Element

Heat Sink  
LED Module  
Hyflex™ Optics  
8 Available Beam Options  
10° - 90°

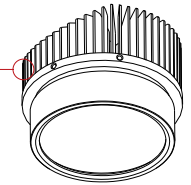

### Lens

Frosted  
Soft Diffused



### Baffle

3 Baffle Positions - Flush, ½", and 1"  
Textured Matte White Finish  
Textured Matte Black Finish  
Custom Finish specify RAL#

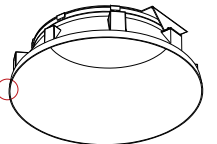

### Baffle Cover

Textured Matte White Finish  
Textured Matte Black Finish  
Custom Finish Specify RAL#

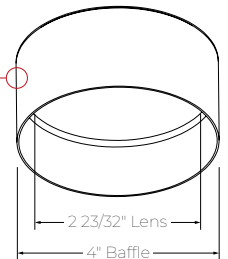

### Mounting

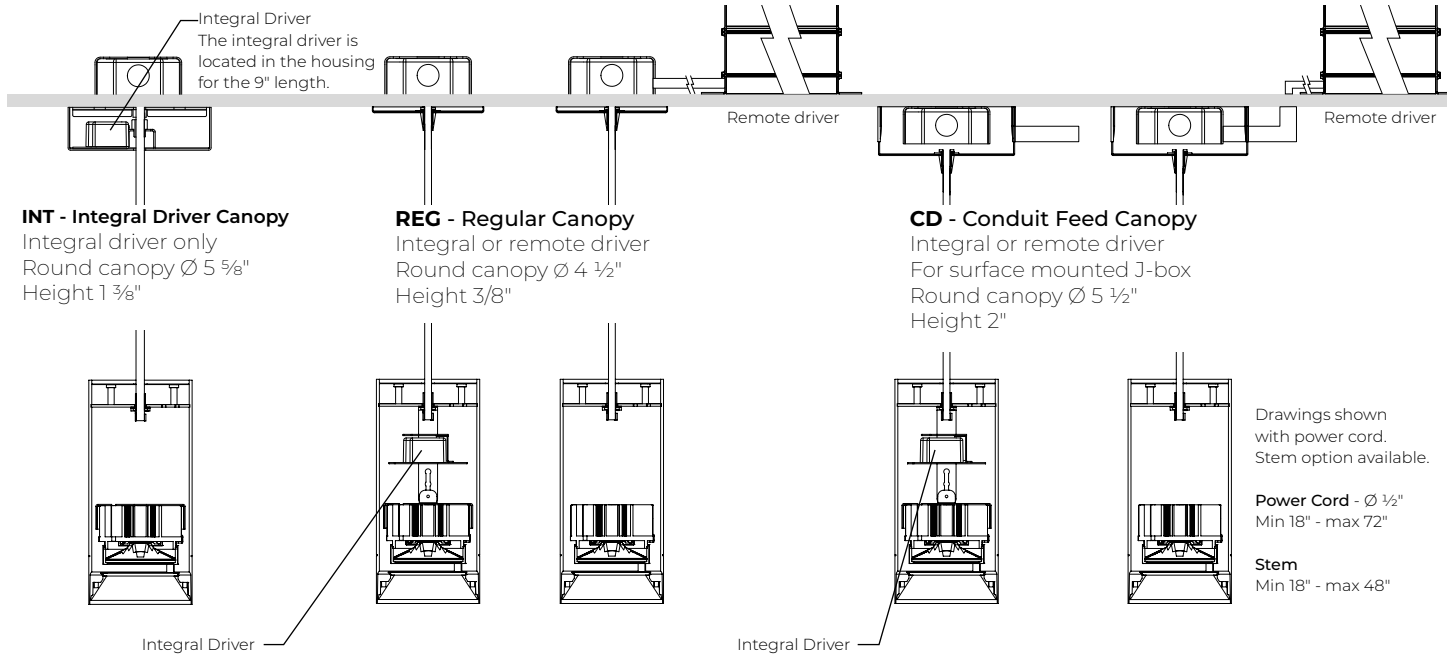

### Optics

Hyflex™ optics provide precise optical control in a remarkably compact form.

The core of this four-tier system is compound reflector with a central TIR element, just 1.06" deep.

Beam-smoothing discs perfect beam angles up to 90°. Beam angles are easily interchanged in the field.

### Light Source - LED

Compact COB (Chip-On-Board) LED module, available in 2700K, 3000K, 3500K and 4000K with a choice of 80+ CRI or 90+ CRI with elevated R9 value (for 95+ CRI, consult factory). Color consistency is maintained to within 2 SDCM. All LEDs have been tested in accordance with IESNA LM-80-08 and the results have shown L80 lumen maintenance greater than 60,000 hours. Absolute product photometry is measured and presented in accordance with IESNA LM-79, unless otherwise indicated.

### Beam Angles

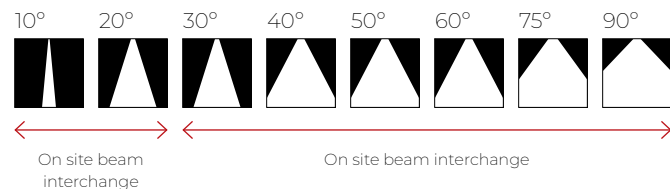

Chromawerx SOLA is single-channel control that dims output while warming the color temperature in a pre-determined relationship. A simple or analog control adjusts a specially populated LED array to emulate the effect of dimming a filament source.



Chromawerx DUO offers a two-channel control system which uses analog or digital protocols for synchronous control of both warm (2700K) to cool (6500K) LED arrays - maintaining a CRI above 90. The range of color DUO offers is useful for entraining circadian rhythms, stimulating alertness, and compensating for jet lag among other applications. The Chromawerx drivers are programmed to limit maximum light output and power usage across all color temperatures.

**DUO** GENERIC DMX NETWORK ARCHITECTURE

A qualified DMX integrator is required to assure proper installation and commissioning of the DMX network. **When placing the PO, please provide the contact information of your DMX integrator.**

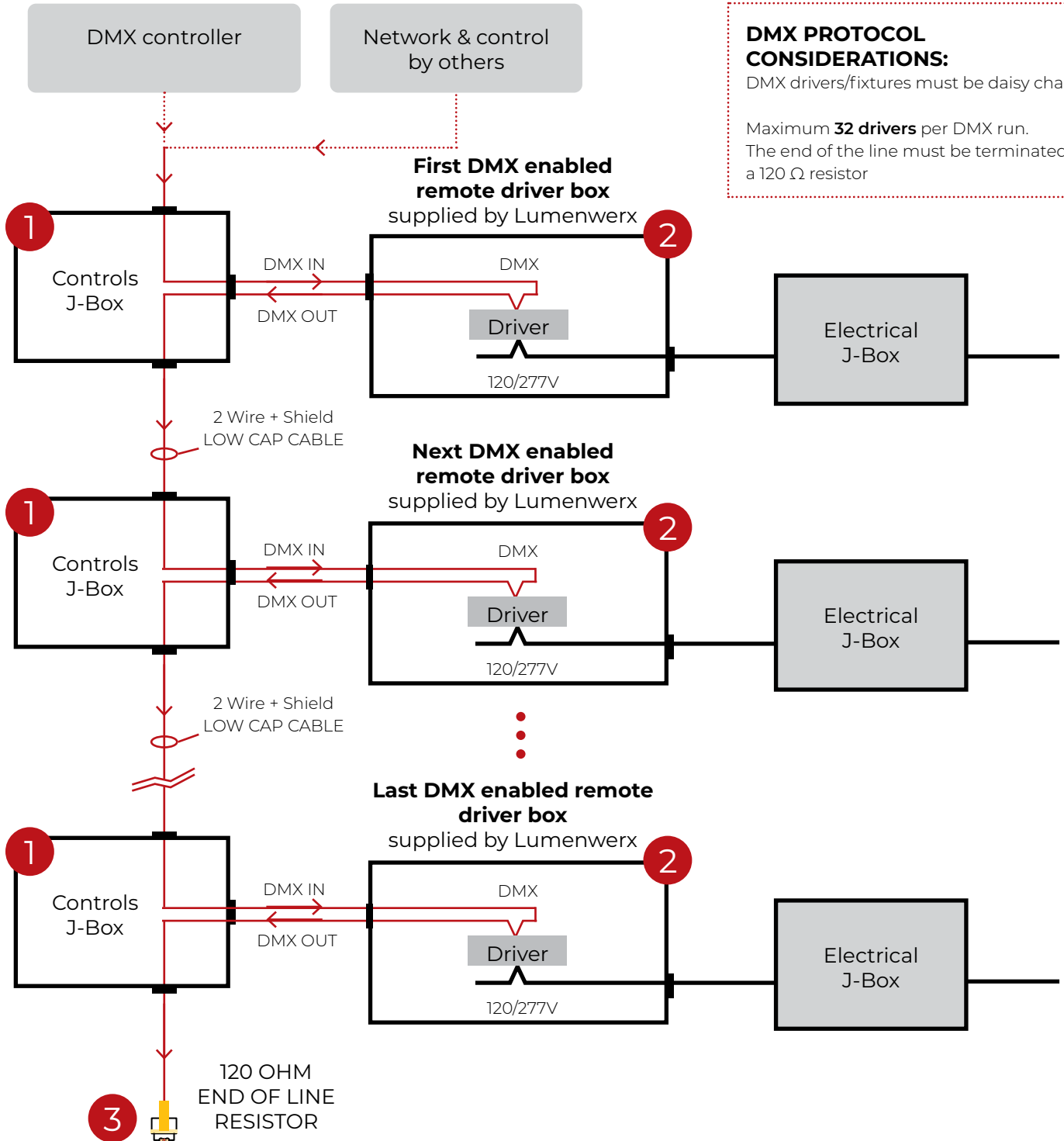

**DMX PROTOCOL CONSIDERATIONS:**  
 DMX drivers/fixtures must be daisy chained.  
  
 Maximum **32 drivers** per DMX run.  
 The end of the line must be terminated by a 120 Ω resistor

## 1 J-BOX DMX DAISY CHAIN DETAIL

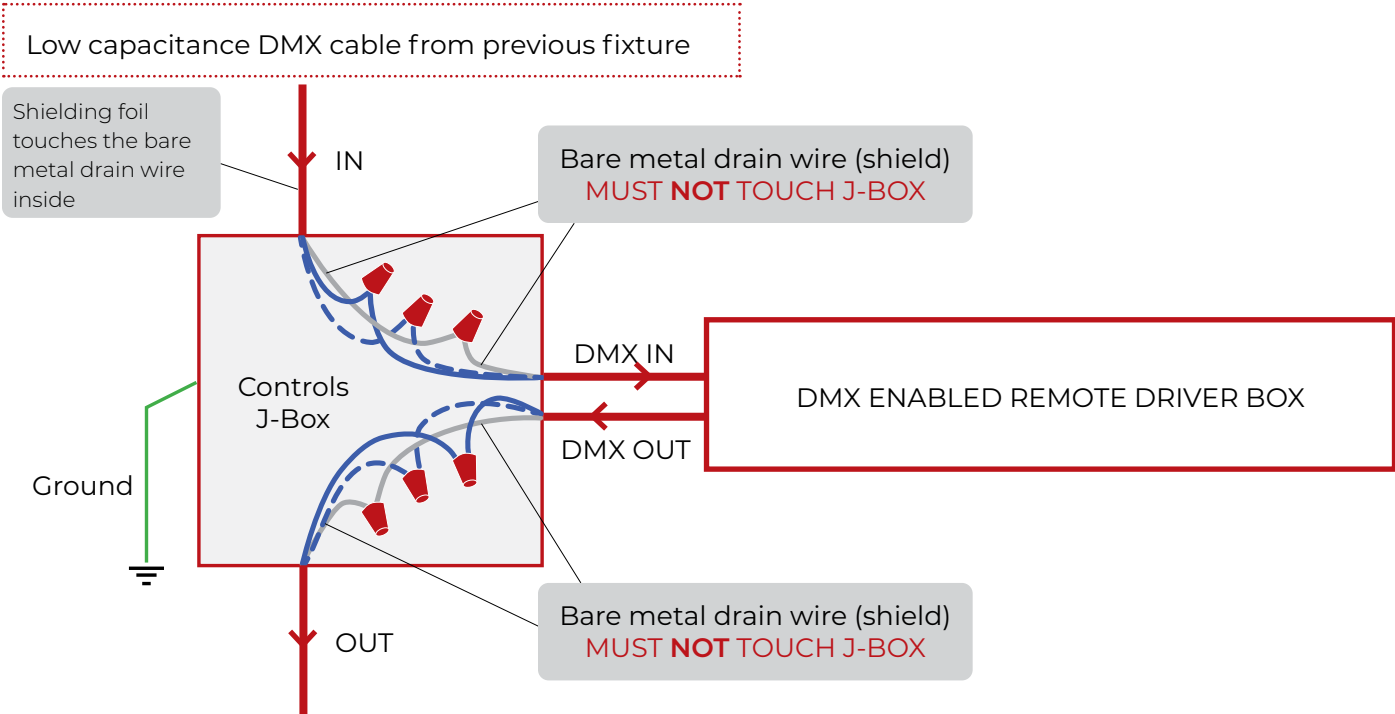

Low capacitance DMX cable to next fixture

## 2 DMX CONNECTION REMOTE DRIVER

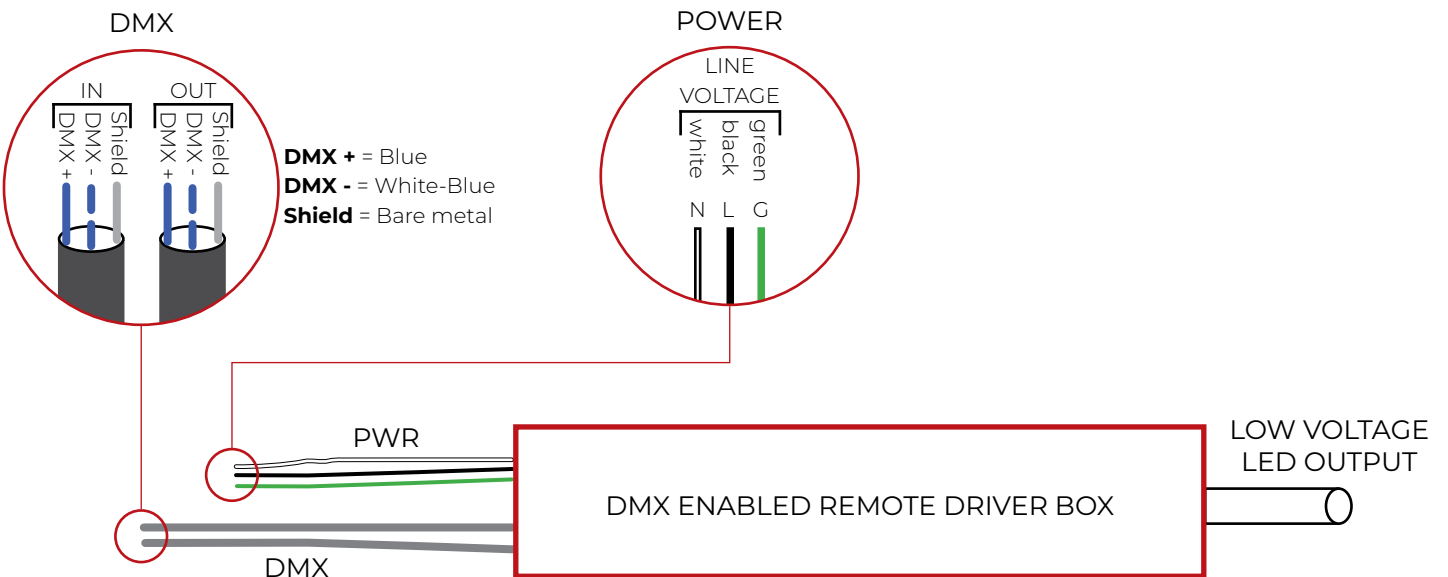

**3** LAST DMX CONNECTION DETAIL

