

Voilà

4" Round Downlight
Wall Wash



Project: _____

Type: _____

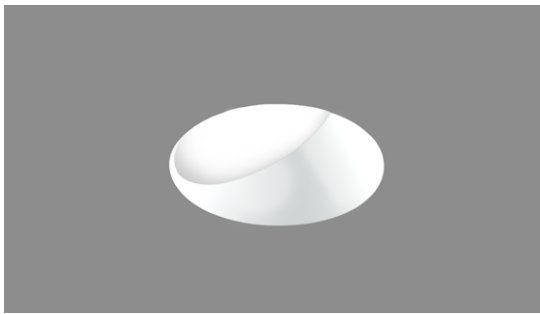

Trimless



Trim



Voila 4" wall wash downlights feature innovative Hyflex™ optics for precise beam control. Shallow construction requires only 4" recess depth. Driver can be replaced through 2" aperture. The Voila COB source with 90+ CRI and 2-step color consistency matches other Lumenwerx luminaires, and is available with Chromawerx SOLA (dim-to-warm) and DUO (tunable white), as well as emergency option. Complete Voila offering includes 2" and 4" apertures; downlights, adjustables, and wall washers; round and square trim; and cylinders; see separate specifications.

Performance

| LUMEN OUTPUT ¹ | WATTS | EFFICACY LM/W |
|---------------------------|-------|---------------|
| 1114 lm | 14 W | 80 lm/W |
| 1511 lm | 20 W | 76 lm/W |
| 2036 lm | 28 W | 73 lm/W |

¹ Lumens packages are assuming 3500K, 80CRI, round white baffle

Delivered Lumens

| CRI | 80+ CRI (At 3500K) | 90+ CRI (At 3500K) | 95+ CRI (At 3000K) |
|-----------------|-----------------------|-----------------------|-----------------------|
| Low - 13.8 W | 1114 | 1036 | 891 |
| Medium - 19.7 W | 1511 | 1405 | 1208 |
| High - 28 W | 2036 | 1893 | 1628 |

Aperture Size

4.00"

Configurations



Fixed, adjustable & wall wash (see other spec sheets for all the configurations)

Baffle Depth



Standard 1.00"

Trim



Trim & Trimless

Baffle & Trim Flange Finishes

Textured matte white
Textured matte black
Mixed black & white
Custom RAL



Color Temperature

2700K
3000K
3500K
4000K
SOLA
DUO



Delivered 1114-2036 lm
14-28 Watts, up to 80 lm/W

Integral Drivers

0-10V, TRIAC, ELV, eldoLED & Lutron

Remote Drivers

Lutron, eldoLED and other drivers

Emergency battery pack

1 - Housing (Example: VO4RRWW-TRM-SW-OF-ASB-120-14W-D1)

Product Specification

| LUMINAIRE ID | TRIM STYLE | LIGHT SOURCE | INSTALLATION TYPE | MOUNTING OPTION | VOLTAGE | WATTAGE (80+ CRI) * | DIMMING | |
|---|------------|--|---|--|---|--|---|--|
| VO4RRWW | | | | | | | | |
| VO4RRWW - Voila 4" Round Recessed Wall Wash TRM - Flanged trim TLMP - Trimless drywall mudplate TLMW - Trimless millwork SOLA ¹ - Dim-to-warm DUO ¹ - Tunable white ¹ Available with OF housing only. | | SW - Static white SOLA ¹ - Dim-to-warm DUO ¹ - Tunable white ¹ Available with OF housing only. | OF - Open frame type non-IC IC ² - IC rated CP ² - Chicago Plenum type-IC (CCEA) ² IC/CP with low output only. | ASB - Adjustable standard bar hangers (grid and drywall) FMB - Flush mount bars (drywall only) ACB - Adjustable commercial bar hangers (grid and drywall) AHC - Adjustable hat channel bars NA - No bar hangers | 120 - 120V 277 - 277V UNV - 120V-277V 347 ³ - 347V ³ Available with 0-10V dimming options DI, RDI and RSD1 only. Consult factory for details. | 14W - Low output 1114 lm 20W ⁵ - Medium output 1511 lm 28W ⁵ - High output 2036 lm For other lumen packages, please consult factory. ⁴ For delivered lumens and other CRI, see multiplier tables on page 3. ⁵ Available with OF housing only. | INTEGRAL DI - 1% 0-10V ELV ⁶ - ELV 120V TRI ⁶ - TRIAC 120V LDE1 ⁷ - Lutron Hi-lume 1% Eco DA ⁷ - DALI ELDO ⁷ - eldoLED 0.1% ELD1 ⁷ - eldoLED 1% DEB ⁹ - 0-10V with onboard emergency battery backup ⁶ Available with 120V only. ⁷ Not available with CP installation type. ⁸ On-site commissioning is required. ⁹ Available with OF housing only. | REMOTE RDI - 1% 0-10V RELV ¹⁰ - ELV 120V RTRI ¹⁰ - TRIAC 120V RLDE1 ¹¹ - Lutron Hi-lume 1% Eco RDA ¹¹ - DALI RELD0 ¹¹ - eldoLED 0.1% RELD1 ¹¹ - eldoLED 1% ¹⁰ Available with 120V only. ¹¹ On-site commissioning is required. +EB ¹² - Emergency battery ¹² Specify with remote dimming only. The code will be like the following example: RDI+EB . |
| | | | | | | | SOLA SDI - Single 0-10V input DUO DMX ⁸ - To specify, see pages 7 to 9 DDA ⁸ - DALI DT6 DDA8 ⁸ - DALI DT8 DD1 - Dual 0-10V input for CCT/intensity LD2 ⁸ - Lutron DALI-2 digital | SOLA RSD1 - Single 0-10V input DUO RDMX ¹¹ - To specify, see pages 7 to 9 RDDA ¹¹ - DALI DT6 RDDA8 ¹¹ - DALI DT8 RDD1 - Dual 0-10V input for CCT/intensity RLD2 ¹¹ - Lutron DALI-2 digital |

2 - Light (Example: VO4WW-SW-WW-2-90-27)

| LUMINAIRE ID | LIGHT SOURCE | BEAM | COLOR QUALITY | CRI | COLOR TEMP. |
|--|--------------------------|-----------------------|-----------------------------------|---|--|
| VO4WW | | WW | | | |
| VO4WW - Voila 4" Wall Wash SOLA - Dim-to-warm DUO - Tunable white | SW - Static white | WW - Wall wash | 2 - 2 Step MacAdam Ellipse | 80 - 80+ CRI 90 - 90+ CRI 95 - 95+ CRI | 27 - 2700K 30 - 3000K 35 - 3500K 40 - 4000K |
| | | | 3 - 3 Step MacAdam Ellipse | 90 - 90+ CRI (SOLA and DUO) | SOLA - Dim-to-warm 35K-22K DUO - Tunable white 65K-27K |

3 - Baffle (Example: VO4RRB-TRM-WW-SR-TMW-TMW)

| LUMINAIRE ID | TRIM STYLE | LENS | BAFFLE POSITION | BAFFLE FINISH | TRIM FLANGE FINISH |
|---|------------|--------------------------------|------------------------------|---|---|
| VO4RRB | | WW | SR | | |
| VO4RRB - Voila 4" Round Recessed Baffle TRM - Flanged trim TLMP - Trimless drywall mudplate TLMW - Trimless millwork | | WW - Wall wash diffuser | SR - Standard regress | TMW - Textured matte white TMB - Textured matte black CF# - Custom finish, specify RAL#. (e.g. CF102B) | TMW ¹³ - Textured matte white TMB ¹³ - Textured matte black CF# ¹³ - Custom finish, specify RAL#. (e.g. CF102B) NA - None |
| | | | | | ¹³ Applicable for TRM only. |

Photometrics

Please follow the multiplier tables to ensure correct lumen value. Baffle color, CCT, CRI and baffle shape will change the lumen value.

36" from Wall - 48" Spacing

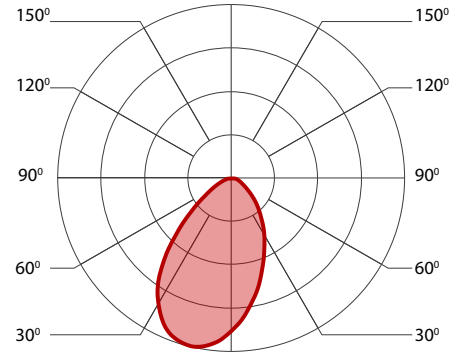
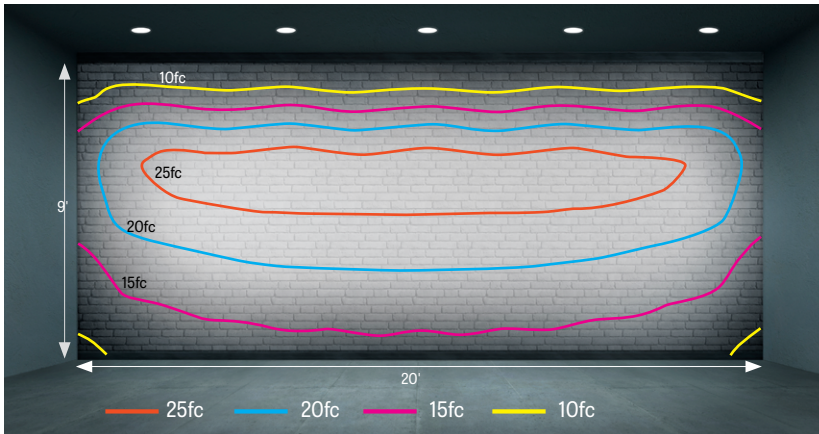

Foot-Candles for Round White Wall Wash Baffles

| FC ON WALL 36" FROM WALL - 36" SPACING | | | | 36" FROM WALL - 48" SPACING | | | 36" FROM WALL - 60" SPACING | | | |
|--|----|-----------------------|-----------------------|-----------------------------|-----------------------|-----------------------|-----------------------------|-----------------------|-----------------------|-----------------------|
| DISTANCE FROM CEILING | | 80+ CRI (At 3500K) | 90+ CRI (At 3500K) | 95+ CRI (At 3000K) | 80+ CRI (At 3500K) | 90+ CRI (At 3500K) | 95+ CRI (At 3000K) | 80+ CRI (At 3500K) | 90+ CRI (At 3500K) | 95+ CRI (At 3000K) |
| | 3" | | 7 | 7 | 6 | 5 | 5 | 4 | 4 | 4 |
| 6" | | 8 | 8 | 7 | 6 | 6 | 5 | 5 | 5 | 4 |
| 12" | | 11 | 10 | 9 | 8 | 7 | 6 | 7 | 6 | 5 |
| 2' | | 25 | 22 | 19 | 19 | 17 | 15 | 17 | 15 | 13 |
| 3' | | 37 | 33 | 29 | 28 | 25 | 22 | 24 | 21 | 18 |
| 4' | | 40 | 36 | 31 | 30 | 27 | 23 | 24 | 22 | 19 |
| 5' | | 37 | 33 | 29 | 28 | 25 | 22 | 22 | 20 | 17 |
| 6' | | 32 | 29 | 25 | 24 | 22 | 19 | 19 | 17 | 15 |
| 7' | | 28 | 25 | 23 | 21 | 19 | 16 | 17 | 15 | 13 |
| 8' | | 24 | 22 | 19 | 18 | 17 | 15 | 14 | 13 | 11 |

Delivered Lumens

| CRI | 80+ CRI (At 3500K) | 90+ CRI (At 3500K) | 95+ CRI (At 3000K) |
|-----------------|-----------------------|-----------------------|-----------------------|
| Low - 13.8 W | 1114 | 1036 | 891 |
| Medium - 19.7 W | 1511 | 1405 | 1208 |
| High - 28 W | 2036 | 1893 | 1628 |

Efficacy Based on Delivered Lumens - High 28 W

| | LPW |
|---------|-----|
| 80+ CRI | 73 |
| 90+ CRI | 68 |
| 95+ CRI | 58 |

Multiplier - CCT

| CCT | |
|-------|------|
| 2700K | 0.9 |
| 3000K | 0.95 |
| 3500K | 1 |
| 4000K | 1.05 |

Multiplier - Baffle Color and Shape

| BAFFLE VARIABLES | | |
|------------------|--------|------|
| White | Round | 1 |
| White | Square | 1 |
| Black | Round | 0.95 |
| Black | Square | 0.95 |

For SOLA and DUO, please consult factory.

Technical Specification

DESCRIPTION Compact fixed 4" wall wash with multiple output, color, and dimming options.

HOUSING CONSTRUCTION For new construction, 20 gauge powder coated steel. Open frame, type-IC, or Chicago Plenum (CCEA) rated. 18 gauge galvanized steel junction box with ½" trade size knockouts. Adjustable standard, flush mount, adjustable commercial, and adjustable hat channel bar hangers are available as mounting options.

Clearance Height: Open frame/Type-IC/Chicago Plenum: 4";
Open frame with DEB or LD2 (DUO) options: 8"

Ceiling Thickness: Can accommodate ½" to 1"

Housing weight: Type-IC/Chicago Plenum - 8 lbs - 3.6 kg;
Open Frame - 6 lbs - 2.7 kg

Ceiling cut out: Ø 5 5/32"

LIGHT ELEMENT

LED Module: Integral COB module. 90+ CRI and 2 SDCM, Standard with options of 80+ CRI, or 95+ CRI. L80 > 60,000 hours

Light Output: From 1114-2036 lumens

HyFlex™ Optics: Proprietary TIR/reflector

Thermal Management: Cold-forged aluminum heat sink to maximize thermal dissipation

WALL WASH BAFFLE

Round die-cast aluminum retained with rare earth magnets (trimmed) or clips (trimless). Integral angled wall wash lens.

Trim style options: Round and square with flanged trim, trimless with mudplate for drywall, or trimless for millwork.

CHROMAWERX SOLA (dim-to-warm) and DUO (tunable white). See pages 6 for more information.

ELECTRICAL

Integral: 0-10V, ELV, TRIAC, Lutron Hi-Lume EcoSystem, DALI, eldoLED 0.1%, eldoLED 1%, DMX, Lutron DALI-2 digital

Remote: 0-10V, ELV, TRIAC, Lutron Hi-Lume EcoSystem, DALI, eldoLED 0.1%, eldoLED 1%, DMX, Lutron DALI-2 digital

Emergency Options: Emergency battery back-up options are available as integral (Fulham), or remote (Fulham, Bodine, or IOTA). The battery provides 10 W of power.

ENVIRONMENT Ambient temperature at fixture location shall be within 0°C/32°F - 25°C/77°F, indoor dry or damp as well as outdoor damp use (canopies or marquees).

LISTING cETLus listed to UL 1598 and CAN/CSA Standard C22.2 No. 250.0

WARRANTY 5 year limited warranty on LED module and power supply. Guaranteed to maintain 70% lumen maintenance.

Installation Types

Open Frame

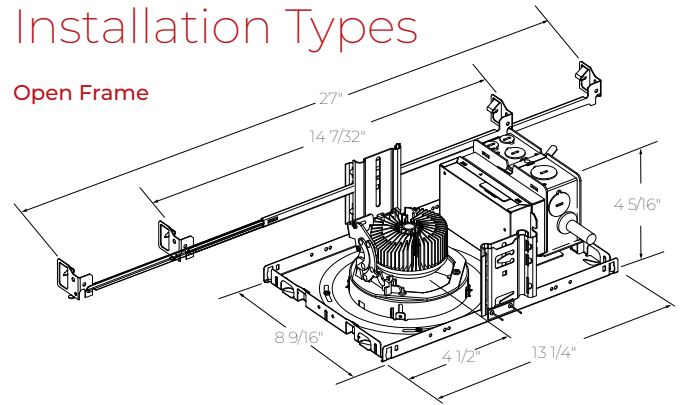

Type-IC / Chicago Plenum

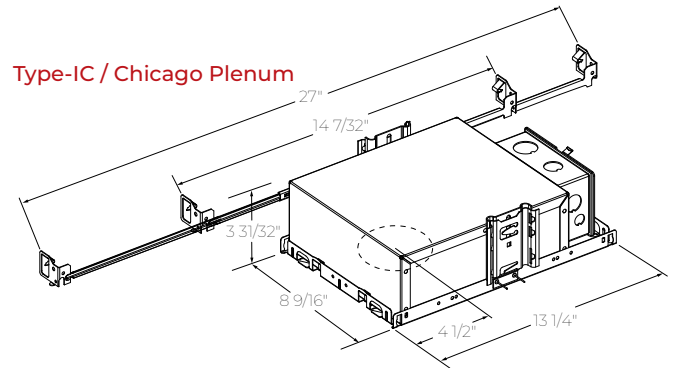

Mounting Options

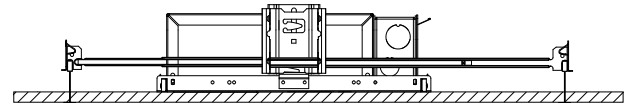

ASB - Adjustable Standard Bar Hangers

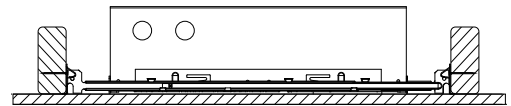

FMB - Flush Mount Bars

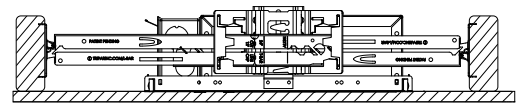

ACB - Adjustable Commercial Bar Hangers

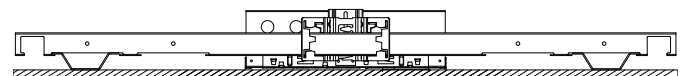

AHC - Adjustable Hat Channel Bars

Voilà

4" Round Downlight
Wall Wash



Project: _____

Type: _____

Light

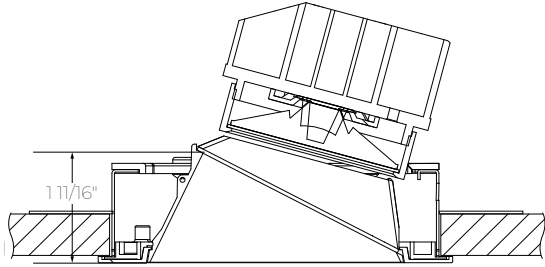

Standard Baffle

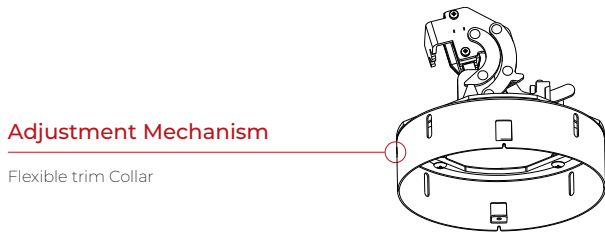

Adjustment Mechanism

Flexible trim Collar

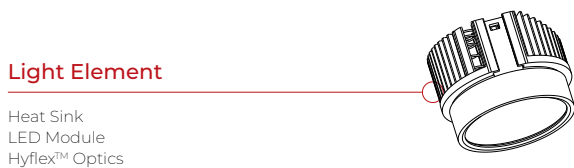

Light Element

Heat Sink
LED Module
Hyflex™ Optics



Retaining Ring

Magnetic Snap



Baffle & Lens

Standard Regress
Wall Washer Lens



Trim

Trim and Trimless

Optics

Hyflex™ optics provide precise optical control in a remarkably compact form. The core of this four-tier system is compound reflector with a central TIR element, just 1.06" deep.

Light Source - LED

Compact COB (Chip-On-Board) LED module, available in 2700K, 3000K, 3500K and 4000K with a choice of 80+ CRI or 90+ CRI with elevated R9 value (for 95+ CRI, consult factory). Color consistency is maintained to within 2 SDCM. All LEDs have been tested in accordance with IESNA LM-80-08 and the results have shown L80 lumen maintenance greater than 60,000 hours. Absolute product photometry is measured and presented in accordance with IESNA LM-79, unless otherwise indicated.

Beam



Wall Wash

Integral Driver

Unless otherwise specified, Voilà comes standard with an integral, 120-277 VAC/60Hz, electronic, 1% 0-10V dimming, constant-current LED driver. The driver is field replaceable and features a high power factor, low THD and sources 1 mA on the 0-10V dim line. All integral drivers are located inside the housing and are easily accessible from below the ceiling through the aperture. All dimming drivers comply with IEEE C62.41 surge protection requirements.

Emergency Integral

Factory installed, long-life, high-temperature, LED driver with integrated emergency backup using a recyclable LiFePO4 battery pack. Features a remote test switch with charge indicator, minimum of 90 minutes operation and 10 W per downlight emergency lighting output. Recharge time of 12 hours.

Emergency Remote

Long-life, high-temperature, emergency LED driver with Lithium Ion battery pack. Features a test switch with charge indicator, minimum of 90 minutes operation and 10 W per downlight emergency lighting output. Recharge time of 24 hours.

Voilà

4" Round Downlight
Wall Wash



Project: _____

Type: _____

Trim Dimensions

Trimless (TLMP, TLMW)

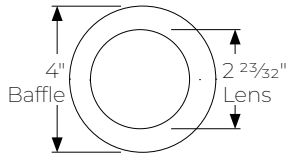

Trim (TRM)

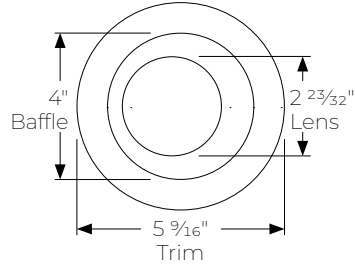

Chromawerx SOLA is single-channel control that dims output while warming the color temperature in a pre-determined relationship. A simple analog control adjusts a specially populated LED array to emulate the effect of dimming a filament source.



Chromawerx DUO offers a two-channel control system which uses analog or digital protocols for synchronous control of both cool (6500K) to warm (2700K) LED arrays - maintaining a CRI above 90. The range of color DUO offers is useful for entraining circadian rhythms, stimulating alertness, and compensating for jet lag among other applications. The Chromawerx drivers are programmed to limit maximum light output and power usage across all color temperatures. When paired with DALI drivers (DDA/DDA8), color tuning follows a linear dimming curve.

Baffle



Standard Regress

Trimless (TLMP, TLMW)

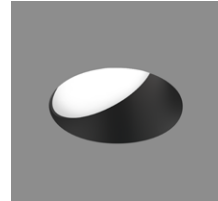

Black Baffle

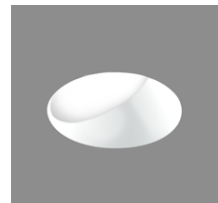

White Baffle

Trim (TRM)

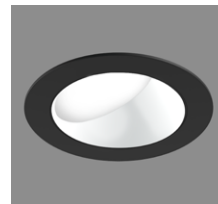

White Baffle,
Black Trim



Black Baffle,
White Trim

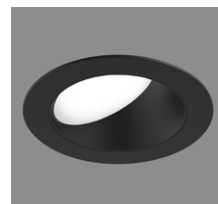

Black Baffle,
Black Trim



White Baffle,
White Trim

DUO GENERIC DMX NETWORK ARCHITECTURE

A qualified DMX integrator is required to assure proper installation and commissioning of the DMX network. **When placing the PO, please provide the contact information of your DMX integrator.**

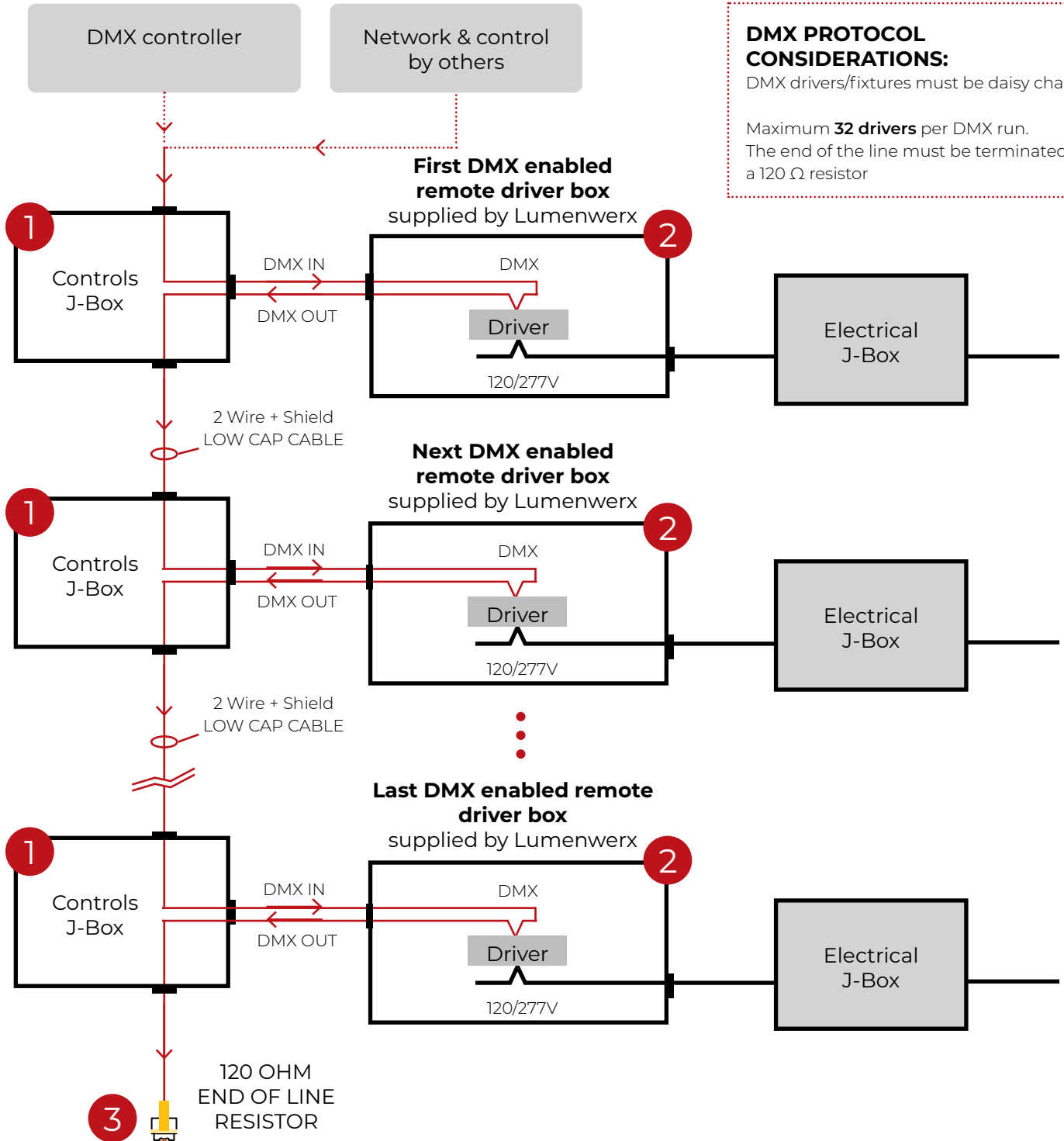

DMX PROTOCOL CONSIDERATIONS:
DMX drivers/fixtures must be daisy chained.

Maximum **32 drivers** per DMX run.
The end of the line must be terminated by a 120 Ω resistor

1 J-BOX DMX DAISY CHAIN DETAIL

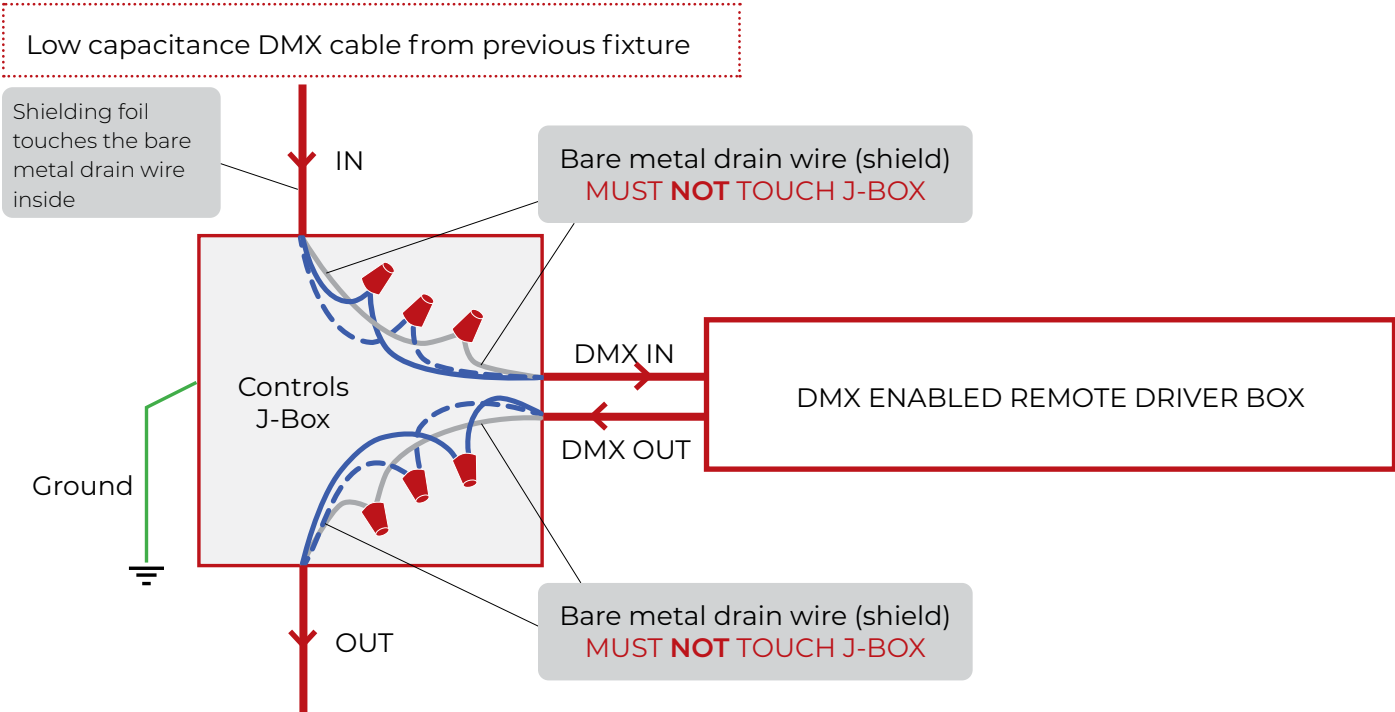

Low capacitance DMX cable to next fixture

2 DMX CONNECTION REMOTE DRIVER

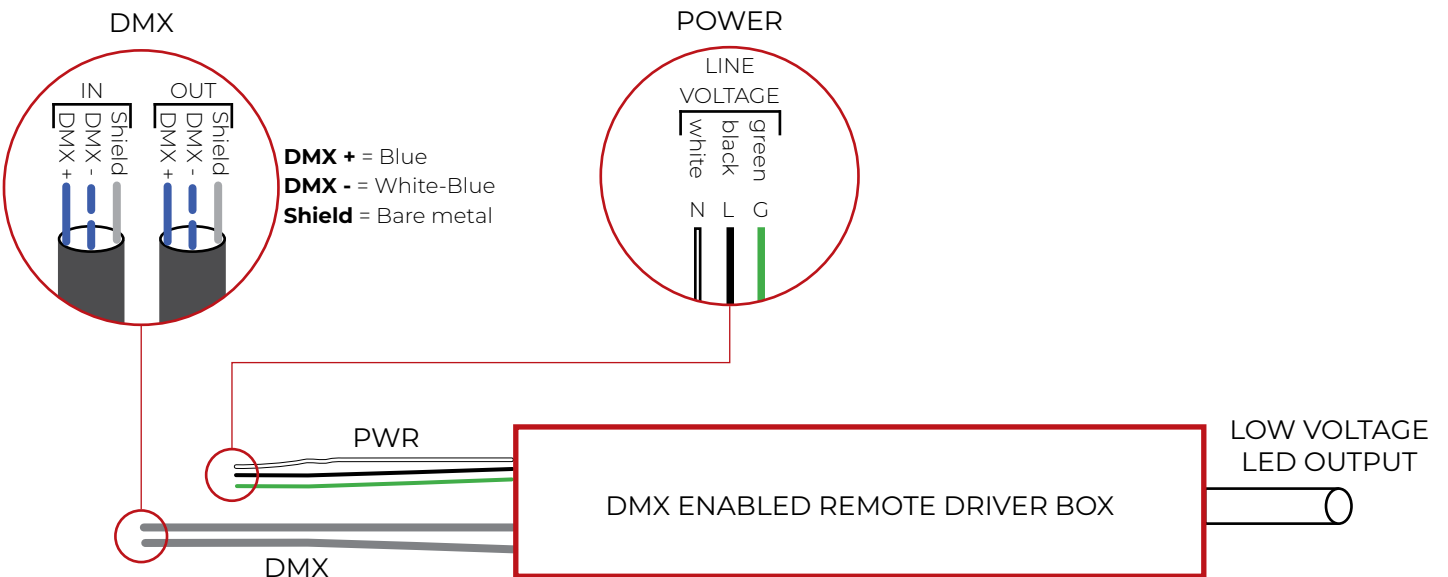

3 LAST DMX CONNECTION DETAIL

